

Gira 4-key EIB SmartSensor
Dual EIB bus coupler

Order no.: 1246 651, 1246 661, 1246 671

Installation Instructions

Information

The Gira SmartSensor is a product of the Instabus KNX/EIB System and complies with KNX/EIBA directives.

The functions of the device depend on the software.

The SmartSensor makes use of modern electronics and electrical installation technology to communicate with other EIB devices in the house and can therefore be used flexibly and in compliance with the user's requirements for many different applications.

The present instructions contain information about the essential functions and operation of the device.

If you have questions concerning the Gira SmartSensor or special wishes as to its functions, please contact your electrical fitter.



Danger

Attention! This device contains no elements which can be serviced by the user. Installation and mounting should only be effected by an electrician specialist!

Failure to observe the instructions may damage the device and cause fire or other hazards.

Function

LC display (1) and control knob (2)

Display of messages and system states • control of EIB devices with control knob / pushbutton • touch sensor functions • time-of-day and date display (only with time synchronization via EIB) • display of actual, setpoint and outside temperature • sleep mode with master function

Touch sensor function (3)

Each rocker key can be separately programmed for:

Switching • toggling • dimming (single-sided or double-sided actuation of key) • shutter control • level transmitter • recalling / storing of light-scenes • status LED (4) • selection of controller operating mode • presence pushbutton • disabling of individual or all key functions

Room temperature control function

Heating / cooling • comfort mode • standby mode • night-time mode • frost / heat protection • dew-point mode • comfort prolongation

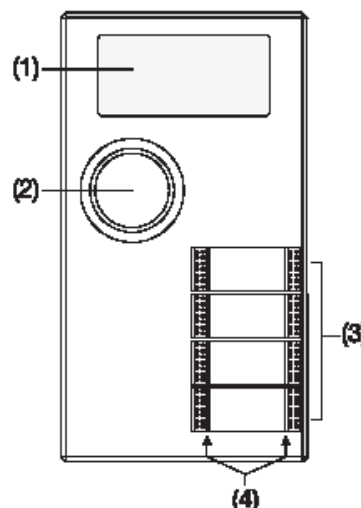

Configuration

(to be filled-in by the electrician)

	Left	Right
Controlknob	<i>Operation LC-display</i>	
Rocker 1:		
Rocker 2:		
Rocker 3:		
Rocker 4:		
Master-function:		
Password:		
Fitting location:		

LC-display

Symbols

▼	indicates further lines below actual highlighted line
▲	indicates further lines above actual highlighted line
	standby mode“
	comfort mode
	night-time mode
	room being heated
	room being cooled
	controller disabled, e.g. dew-point alarm
	room temperature indication
	outside temperature indication

	rocker operation completely or partly disabled
	fan running
0...9	fan intensity level
	service mode active
	password-protected functions active
	alarm triggered or still active

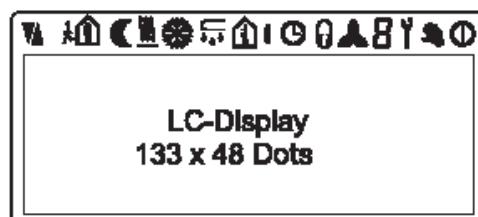

Operation

Control knob

The LC-display is operated only with the control knob. The following functions are available:

(1) Turning:

navigation in menu structure, i.e. the bar is moved up and down.

(2) Brief actuation (press):

selection of a page or a function; confirmation of selected item or of a value ("Enter").

(3) Long actuation (press):

return to next higher level without entering the selected value ("Esc").

(4) Very long actuation:

activation of service function (see chapter "Service area")

(5) Master function:

If no actuations are registered over a prolonged period, the SmartSensor switches the LC-display off ("Sleep mode").

Pressing/turning of the control knob will now trigger a certain room function.

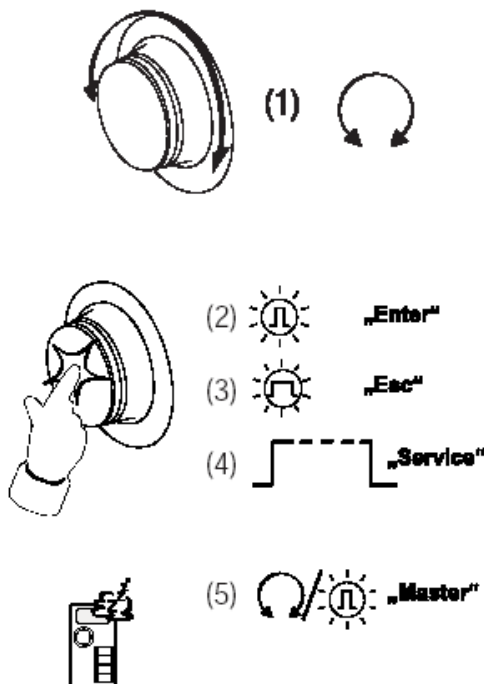

Menu structure

At rest, the LC display displays a title page which can include, for instance, room temperature, time of day, date, graphics, company logo or system states.

After brief actuation of the control knob (turn or press), the menu structure is displayed. The menu structure comprises a maximum of 3 levels in a tree structure. The scope and the contents depend on programming and on the respective installation.

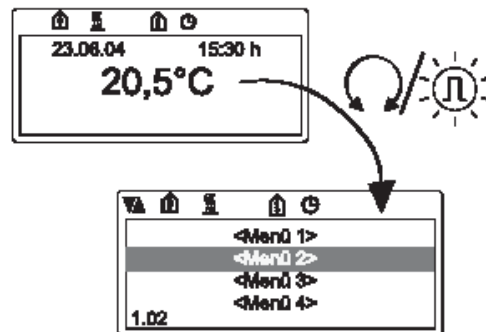

Selecting a menu item

A menu item is selected by moving the marker bar to this menu item and by pressing the control knob briefly.

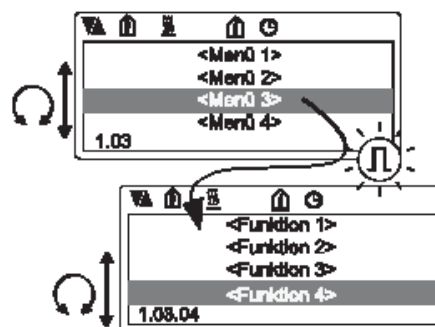

The actual position inside the menu structure can be indicated at the bottom of the LC-display (example: "1.03" – menu 1, then submenu 3 selected).





Functions

Depending on the function activated –switching, dimming, shutter control, light-scene setting, etc. – the type of actuation has different effects:



"Switching" function

-  Brief press: Indication of the state not active. Triggering of the function by brief press.
-  Turn: Selection between "On" and "Off".
-  Long press: Return to previous menu.

"Dimming" function

-  Turn: Adjusting the brightness level. Triggering of the function by brief press.
-  Long press: Return to previous menu.



"Shutter control" function

-  Brief press: Display "UP"
-  Turn: Selection between "UP" and "DOWN". Selection of function by brief press. After selection of "UP" or "DOWN", the display displays "STOP", a new brief press stop the shutter movement.
-  Long press: Return to previous menu.

Important:

If programmed accordingly, the device accepts also predefined positions as values (%).

"Recall light-scene" function



-  Brief press: Recall light-scene ("Set").
-  Long press: Return to previous menu.

"Adjust light-scene" function

The SmartSensor permits modification of light-scenes on the sensor itself by excluding actuators from the scene and by changing the values of individual actuators inside the scene.

The modified scene is then written back into memory by a storage instruction.

Changing a value / excluding from scene

-  Brief press: Display actual actuator value
-  Turn: Change value by turning knob to the right. Exclude actuator by turning knob to the left to "nn". Adopt new setting by another brief press.
-  Long: Quit setting without storing

Room temperature controller

By means of an integrated room temperature sensor the room temperature controller is enabled to control an existing heating / cooling system.

The setpoint temperature and the operation of the heating and cooling appliances depends on the operating mode of the controller.

Modes of operation**Comfort mode / comfort prolongation**

Setpoint temperature during the presence of persons, e.g. 20°C.

The comfort prolongation can be activated during night-time or frost / heat protection mode (exception: windows open) – e.g. by pressing the comfort button (if programmed, or by a presence detector, etc.). The setpoint temperature of the comfort mode is then activated for a preset time – e.g. 1 hour.

Thereafter, the controller switches back to the original mode of operation.

Standby mode

Temperature reduction during a brief absence of persons; when the controller goes back to the comfort mode, the room temperature can be quickly brought back to the reference value set for the comfort mode.

Night-time mode ("Economy")

Setpoint temperature for the night or other prolonged periods during which a room is not used for energy-saving purposes.

Frost / heat protection

Useful for energy saving, for instance, when windows are open. The heating is activated only to such an extent that the heating pipes do not freeze in (frost protection); installed cooling appliances are activated only to such an extent that rooms are not overheated (heat protection, e.g. to prevent health hazards for persons with circulatory problems).

Alarm list

The SmartSensor can handle up to 12 different alarm messages.

On reception of an alarm message, the alarm list is displayed until all alarms have been confirmed. To confirm, the individual alarms must be selected by turning the control knob and by pressing this knob.

The alarm symbol  is displayed until all alarms have been deactivated.

Disabling of functions

The rocker keys of the SmartSensor can be disabled completely or partly. When the SmartSensor is disabled, the "Lock" symbol is displayed.

(Please note programming details!)





disable individual rockers

o 1 o 2 o 3 o 4

all rockers:
behavior like rocker ____

Heating and cooling

Depending on programming, the SmartSensor can:

- (please note programming details)
- heat only 
 - cool only 
 - heat and cool  and 

The operating modes "Comfort", "Standby" and "Night-time" have their own setpoint values for heating and cooling and display these values accordingly.

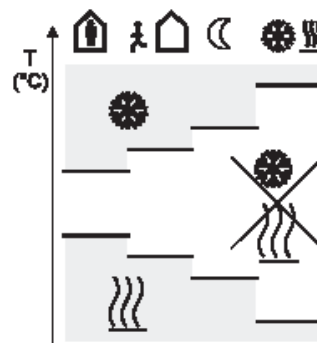

Alarms are displayed in the order of priority. Non-confirmed alarms are on a higher priority level than confirmed ones. An alarm is cancelled by eliminating the cause of the alarm and after the SmartSensor has received a corresponding reset telegram via the EIB.

Depending on importance, alarm messages can be displayed as flashing messages or be accompanied by warning tones.

Dew point / controller disable

The controller function can be disabled, e.g. by the signal from a dew-point sensor. During this time, the rockers are operational and also the modes of operation can be changed.

Password 

Operation of the SmartSensors via the menu structure can be protected completely or partly against unauthorized operation by means of a password. When a password-protected function is selected, the LC-display displays the "Hand" symbol.

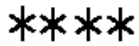

The password is entered by selecting the corresponding menu item (brief press). In the following screen the password is symbolized by 4 asterisks " * * * * " ..

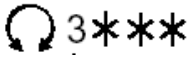

After a new brief press, the first figure (0...9) can be selected by turning the control knob.



A second press confirms the input; the figure is now displayed again as an asterisk ("*") and the next figure can be entered.

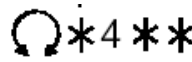

If the entered password is wrong, the device returns to the menu..



If programmed, the password can be changed from a remote location (e.g. visualization software, control panel, etc.). The password is factory-set to "1 2 3 4".

Service area 

If programmed, the "Service area" can be activated where additional menus and settings are offered which are not available in normal operation. When the service area is active, the device displays the "Wrench" symbol.

Paging system

If programmed, the SmartSensor can be used to realize a paging system for transmission of free text messages or for recalling fixed texts.

Example: "janitor service tel. 222"

Depending on importance, the text messages can be displayed as flashing texts or also be accompanied by signalling tones.

Montage Fitting

System information

The Gira SmartSensor can only be used in conjunction with the dual EIB bus coupler.

The dual EIB bus coupler serves at the same time as the controller for an **e2i** system and integrates this system into Instabus EIB installation.

The Gira SmartSensor is a product of the Instabus EIB system and complies with EIBA directives. Detailed technical knowledge is a prerequisite to proper understanding.

The functions of the device depend on the application module used and on parameter programming.

Planning, installation and commissioning of the device are effected with the help of PC software.

The updated product database and the technical description are available in the Internet under www.gira.de.

Description

The Gira SmartSensor is composed of two components:

The dual EIB bus coupler ensures the connection to the EIB and the **e2i** system, serves as an **e2i** controller and supplies the connected **e2i** modules with power. The SmartSensor application module is plugged onto the dual bus coupler and is equipped with the following elements: LC display, control knob (turn/push), control keys and temperature sensor.

The functions of the SmartSensor / dual EIB bus coupler are defined by the parameters programmed into the devices.

Functions

See operating instructions.



Safety warnings

Attention: Electrical equipment must be installed and fitted by qualified electricians only and in strict observance of the relevant accident prevention regulations.

Failure to observe any of the installation instructions may result in damage to the device, in fire and in other hazards.

Installation of the dual bus coupler

- Install the dual EIB bus coupler in a suitable installation box (see Technical Data) or into an ITS 30 dual profile box.
Fitting position see fig. A. Fitting instructions for the ITS 30 are provided in the documentation supplied.
- Use a safety transformer in acc. with DIN EN 61558-2-9 (VDE 0570-2-9) or the unchoked output of a corresponding EIB power supply unit as 24 V power supply.
Connect the power supply with the yellow/white terminal supplied (fig. B, (4)).
- Lay the lines for the external supply and the **e2i** bus line in compliance with the prescriptions for safety extra low voltage (SELV).
- Connection to the EIB must be made with the red/black EIB bus terminal (fig. B, (5)).
- **Important:** The second pair of wires of the EIB bus line can be used for the auxiliary supply. Observe the EIB rules concerning the use of the second pair of wires.
- Connect the wires of the **e2i** bus line by means of the 4- pole terminal supplied (fig. B, (6)) as follows:

Connection of 4-pole e2i bus line

1. red
2. yellow
3. white
4. black

Allocation of physical address:

- Start the address allocation procedure in the EIB software.
- Depress the programming button (fig. A, (1)) until the programming LED is lit up (fig. A, (2)).
Important: This must not be done on several EIB devices at the same time
- The programming LED goes out when the flush-mounted EIB bus coupler has adopted the physical address.

Installation of the SmartSensor application module:

- After programming of the dual EIB bus coupler, the SmartSensor (fig. C, (7)) is plugged onto the bus coupler.
The electrical contact is established by means of the 10-pole interface connector (fig. C, (3)).

Important information:

The interface shown (fig. C, (3)) is not an EIB application interface. For this reason, no EIB application modules must be plugged into this interface. Failure to observe this warning may result in damage to the device and/or in malfunctions.

Busankoppler 2-fach EIB – Oberseite

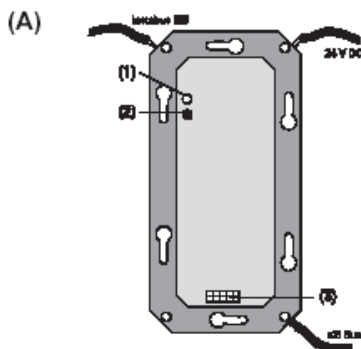

Busankoppler 2-fach EIB – Unterseite

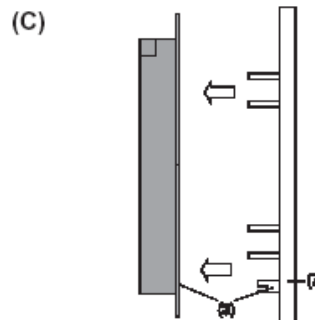
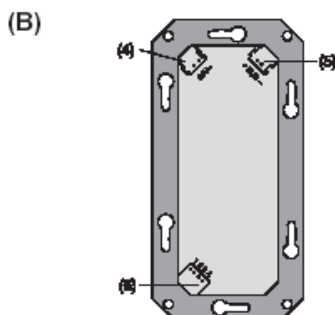

- After plugging in the device for the first time, the LEDs behind the control knob are flashing slowly. The SmartSensor and the dual bus coupler must now be adapted to one another. To do so, depress the control knob briefly. After successful adaptation, the LEDs are switched off.
- The device is protected against removal by a screw; see fig. D.
- Remove the inscription label cover carefully with a screwdriver or the nail of your finger FIG. E.

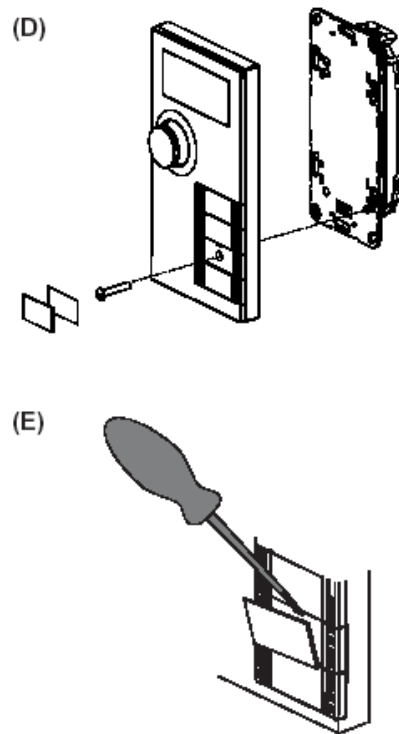

Software download

Program the SmartSensor application module with the EIB commissioning software.

Documentation

Note the physical address on the SmartSensor and on the dual EIB bus coupler. Note the basic programming data in the operating instructions („Configuration“ and „Disabling of functions“ chapters) and hand the operating instructions over to the customer.

Important:

The LED behind the control knob and the key LED of the SmartSensor signal the states of operation, especially in the event of failures (e.g. devices interchanged in operation during renovation work). Further details in this respect can be found in the technical documentation of the device.

Technical data

EIB voltage:	24 V DC (+6 V /-4 V) SELV	Ambient temperature:	-5 °C ... +45 °C
External auxiliary supply:	24 V AC/DC (+/- 3 V) 4 W in acc. with DIN EN 61558-2-9 (VDE 0570-2-9) or unchoked output of EIB power supply (30 V DC)	Storage/transport temp.:	-25 °C ... +70 °C
EIB power consumption:	max. 12 mA at 24 V	Type of protection:	IP 20
Power consumption of auxiliary supply:	max. 12 mA at 24 V	Safety class:	III
Max. line length of e2i bus:	50 m	Fitting depth:	32 mm
Max. number of e2i devices:	6	Suitable installation boxes, e.g.	
Type of e2i bus line:	J-Y(St)Y 2x2x0.6 or J-Y(St)Y 2x2x0.8	flush-mounting:	double unit connection box Kaiser, Art. no. 1656-02
Connection		hollow wall :	double unit connection box Kaiser, Art. no. 9062-02 Kaiser, Art. no. 9062-77 (halogen-free)
e2i system:	4-pole terminal (grey)	concrete:	universal box B2, Spelsberg, Art. no. 974 002 01 plus 2 installation bridges Spelsberg, Art. no. 974 120 01 plus 4 screws Spelsberg, Art. no. 974 130 01
24-V supply:	2-pole terminal (yellow/white)		
EIB:	2-pole terminal (red/black)		

Acceptance of guarantee

We accept the guarantee in accordance with the corresponding legal provisions.

Please return the unit postage paid to our central service department giving a brief description of the fault:

Gira
Giersiepen GmbH & Co. KG
Service Center
Dahlienstrasse 12
D-42477 Radevormwald



The CE sign is a free trade sign addressed exclusively to the authorities and does not include any warranty of any properties.

Gira
Giersiepen GmbH & Co. KG
Postfach 1220
D-42461 Radevormwald

Telefon: +49 / 21 95 / 602 - 0
Telefax: +49 / 21 95 / 602 - 339
Internet: www.gira.de