

Universal LED dimmer DRA

Order no.: 2365 00

Operating instructions**1 Safety instructions**

Electrical devices may only be mounted and connected by electrically skilled persons.

Serious injuries, fire or property damage possible. Please read and follow manual fully.

Danger of electric shock. Always disconnect before carrying out work on the device or load.

Danger of electric shock. Device is not suitable for disconnection from supply voltage. The load is not electrically isolated from the mains even when the device is switched off.

Risk of destruction if the set operating mode and load type do not match. Set correct operating mode when connecting or exchanging the load.

Fire hazard. For operation with inductive transformers, each transformer must be fused on the primary side in accordance with the manufacturer's instructions. Only safety transformers according to EN 61558-2-6 may be used.

These instructions are an integral part of the product, and must remain with the end customer.

2 Intended use**Intended use**

- Switching and dimming of lighting
- Mounting in a sub-distribution unit on DIN rail according to EN 60715
- Operation is performed using the buttons, 2-wire or 3-wire extension with button cover, rotary dimmer extension or push-button with NO contact

3 Product characteristics

- Device works according to the leading edge phase control or trailing edge phase control principle
- Automatic or manual setting of the dimming principle suitable for the load
- Display of the set operating mode by means LED
- Switch-on via bulb-preserving soft start
- Switch on with last saved brightness or saved switch-on brightness
- Switch-on brightness can be saved permanently
- Minimum brightness can be saved permanently
- Electronic short-circuit protection with permanent switch-off after 7 seconds at the latest
- Electronic over-temperature protection

i Power extension possible by means of power boosters.

4 Operation

These instructions describe operation using the buttons on the device and using a 2-wire or 3-wire extension with a button cover or push-button as extension.

i The LED display (1) turns green when the load is switched on.

Switch light

- Press the button ▲ or button cover briefly: Light is switched on at the last set brightness or the stored switch-on brightness.
- Press the button ▼ or button cover briefly: The light is switched off.

i 3-wire extension: Press top to switch on, press bottom to switch off.

Adjust the brightness

Light is switched on.

- Long press the button ▲ or button cover at the top.
The light gets brighter up to maximum brightness.
- Long press the button ▼ or button cover at the bottom.
Light gets darker to minimum brightness.

Switch light on with minimum brightness

- Long press the button ▼ or button cover at the bottom.
Light switches on at minimum brightness.
- Long press the button ▲ or button cover at the top.
Light switches on at minimum brightness and gets brighter.

Save switch-on brightness

In the state as supplied, the switch-on brightness is set to maximum brightness.

- Set light to the required brightness.
- Press the button ▲ and ▼ or button cover over the entire surface for longer than 4 seconds.
Switch-on brightness is saved. For confirmation, the light is switched off briefly and switched on again.

Delete switch-on brightness

- Briefly press the button ▲ or button cover: Light switches on at the saved switch-on brightness.
- Press the button ▲ and ▼ or button cover over the entire surface for longer than 4 seconds.
The switch-on brightness is deleted. For confirmation, the light is switched off briefly and switched on again. Switching on takes place at the last brightness value set.

Operation via push-button as extension

- Press push-button briefly: Light is switched on or off at the last set brightness or a stored switch-on brightness.
 - Long press on the push-button when switched on: Set the brightness. The dimming direction is changed with each new long actuation.
 - Long press on the push-button when switched off: Light switches on at minimum brightness and gets brighter.
-  Saving or deleting the switch-on brightness is not possible.

5 Information for electrically skilled persons

5.1 Fitting and electrical connection

**DANGER!**

Mortal danger of electric shock.

Disconnect the device. Cover up live parts.

Fitting and electrical connection

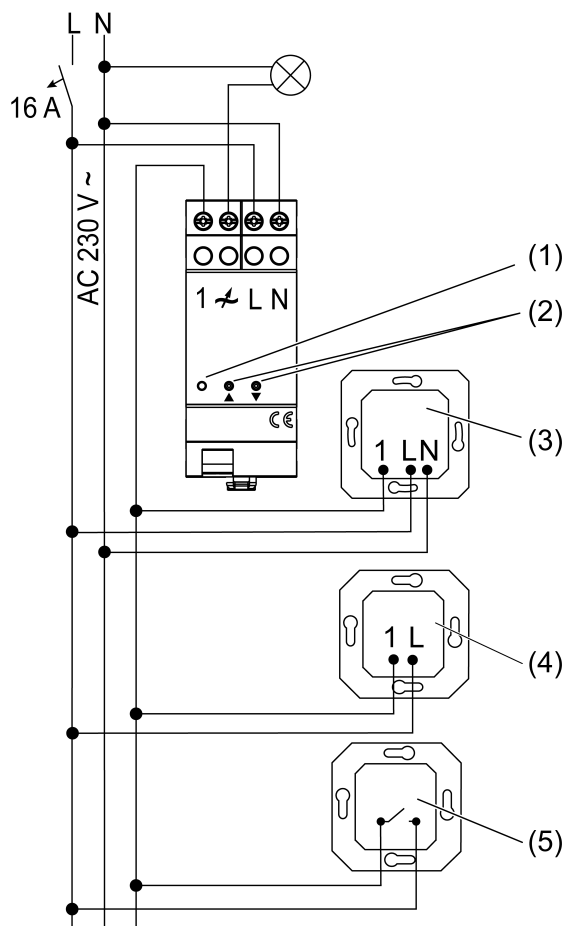

Figure 1: Connection diagram

- (1) LED display
- (2) Release the
- (3) 3-wire, rotary dimmer extension
- (4) 2-wire extension
- (5) Push-button, NO contact

- i** When operating multiple dimmers or power boosters in a sub-distribution, maintain a distance of 1 module, approx. 18 mm, between the devices in order to prevent overheating.
- i** Connect 600 Watt LED lamps or compact fluorescent lamps at most per 16 ampere circuit breaker. When connecting transformers, observe the data of the transformer manufacturer.
- i** Our dimmers take into account the different electronic characteristics of most LED lamps found on the market. However, it cannot be guaranteed that in individual cases the desired results may not be achieved.

Lit push-buttons must have a separate N terminal.

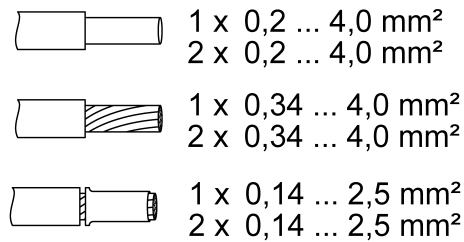

Figure 2: Clampable conductor cross-section

Reset the overheating protection / short-circuit protection

- Disconnect the dimmer from the mains supply.

5.2 Commissioning**Operating mode: Universal, R,L,C,LED (factory setting)**

- Automatic calibration to the load, dimming principle, trailing edge phase control, leading edge phase control or LED leading edge phase control
- Incandescent lamps, HV halogen lamps, dimmable HV-LED or compact fluorescent lamps, dimmable electronic or inductive transformers for halogen or LED lamps.

Operating mode: LED trailing edge phase control, LED \triangleleft

- i** The connection of inductive transformers is not permitted.
- Incandescent lamps, HV halogen lamps, electronic transformers for halogen or LED lamps that can be dimmed according to the trailing edge phase control principle, HV-LED or compact fluorescent lamps that can be dimmed according to the trailing edge phase control principle.

Operating mode: LED leading edge phase control, LED \triangle

- i** The connection of inductive transformers is not permitted.
- Incandescent lamps, HV halogen lamps, electronic transformers for halogen or LED lamps that can be dimmed according to the leading edge phase control principle, HV-LED or compact fluorescent lamps that can be dimmed according to the leading edge phase control principle.

Setting operating mode and minimum brightness

Precondition: Load is switched off.

- Press both buttons \blacktriangle and \blacktriangledown (2) for longer than 10 seconds, until LED (1) lights up (Figure 1).
- Release both buttons \blacktriangle and \blacktriangledown (2).

LED	Dimm-Mode
GN (grün, green)	R,L,C,LED
RD (rot, red)	LED \triangleleft
BU (blau, blue)	LED \triangle

Figure 3: Assignment of LED colour to dimming principle

- Keep briefly pressing button \blacktriangle or \blacktriangledown (2) until the necessary operating mode is selected. The LED (1) lights up in the colour of the selected operating mode (Figure 3).
- Press and hold down both the buttons \blacktriangle and \blacktriangledown (2). The LED (1) flashes in the colour of the selected operating mode. Light switches on at the lowest brightness and slowly becomes brighter.
- i** When changing the operating mode to universal, the calibration to the load is first performed. Keep both buttons (2) pressed.

- i** In the lowest dimming position, a lamp light must be visible.
- Once the desired minimum brightness is reached, release both buttons ▲ and ▼ (2). LED (1) lights up in the colour of the selected operating mode, operating mode and minimum brightness are set.
- Optionally change the minimum brightness again: Press both buttons ▲ and ▼ (2) for longer than 1 second. Light switches again to the lowest brightness and slowly becomes brighter.
- Save the settings: Briefly press the button ▲ or ▼ (2) or do not press for 30 seconds. LED (1) turns green.

6 Technical data

–

Rated voltage	AC 230 V~
Mains frequency	50 / 60 Hz
Ambient temperature	-5 ... +45 °C
Standby power	approx. 0.3 W
Power loss	approx. 3.8 W

Connected load at 45 °C (Figure 4)





			
W 20...420	W/VA 20...420	W 3...100	W/VA 20...100

Figure 4: Connected load

Operating mode **LED** : Max. connected load for HV-LED lamps typ. 3 ... 200 W, electronic transformers with LV-LED typ. 20 ... 200 W.

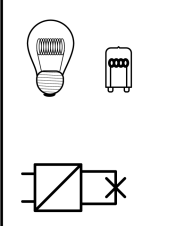
Mixed load

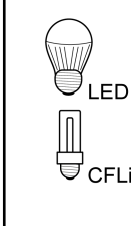
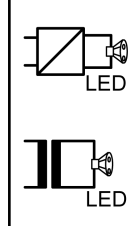
ohmic-inductive	20 ... 420 VA
ohmic-capacitive	20 ... 420 W
capacitive-inductive	not permitted
Ohmic and HV LED	typ. 3 ... 100 W
Ohmic and compact fl lamp.	typ. 3 ... 100 W

- i** Power specifications including transformer power dissipation.
- i** Operate inductive transformers with at least 85% nominal load.
- i** For ohmic-inductive mixed load, maximum 50% proportion of ohmic load. Otherwise incorrect calibration of the dimmer may result.

Power reduction

per 5°C in excess of 45°C	-15 %
Number of extension units	
2-wire, push-button	unlimited
3-wire, rotary dimmer extension	10

Power boosters	See power booster instructions
Total line lengths	
Extension	max. 100 m
pwr cable	max. 100 m
Fitting width	36 mm / 2 module

7 Troubleshooting

Connected LED lamps or compact fluorescent lamps switch off in the lowest dimming position or flicker

Cause: The set minimum brightness is too low.
Increase minimum brightness.

Connected lamps do not switch on in the lowest dimming position or only after a delay

Cause: The set minimum brightness is too low.
Increase minimum brightness.

Connected LED lamps or compact fluorescent lamps flicker or buzz, no correct dimming possible, device buzzes

Cause 1: Lamps are not dimmable.
Check manufacturer's instructions.
Exchange lamps for another type.

Cause 2: Operating mode (dimming principle) and lamps do not optimally match.
Check operation in another operating mode, reduce connected load as well if necessary.
Set the operating mode manually.
Exchange lamps for another type.

Connected LED lamps or compact fluorescent lamps in the lowest dimming position are too bright; dimming range is too small

Cause 1: The set minimum brightness is too high.
Reduce minimum brightness.

Cause 2: Operating mode (dimming principle) does not optimally match the connected HV-LED lamps.
Check operation in another operating mode, reduce connected load as well if necessary.
Set the operating mode manually.
Exchange HV-LED lamps for another type.

The dimmer switches the load off briefly and then on again.

Cause: short-circuit protection has tripped but now there is no longer a fault.

The dimmer has switched off and the load cannot be switched on again

Cause 1: overheating protection has tripped.

Disconnect dimmer from mains by switching off circuit breaker.
LED trailing edge phase control: Reduce the connected load. Exchange lamps for another type.
LED leading edge phase control: Reduce the connected load. Check operation in the LED trailing edge phase control setting. Exchange lamps for another type.
Let dimmer cool down for at least 15 minutes.
Switch circuit breakers and dimmer on again.

Cause 2: Surge protection has triggered.

LED trailing edge phase control: Check operation in the LED leading edge phase control setting, reduce connected load as well if necessary.

Exchange lamps for another type.

Cause 3: short-circuit protection has tripped.

Disconnect dimmer from mains by switching off circuit breaker.

Eliminate short-circuit.

Switch circuit breakers and dimmer on again.

i Short-circuit protection is not based on a conventional fuse, no metallic separation of the operational current.

Cause 4: load failure.

Check load, replace light bulb. For inductive transformers, check primary fuse.

LED lamp flashes repeatedly or is dimly lit when dimmer is switched off

Cause: LED lamp is not suitable for this dimmer.

Use a compensation module, see accessories.

Use another type of LED lamp or an LED lamp of another manufacturer.

8 Accessories

Compensation module LED

Order no. 2375 00

9 Warranty

The warranty is provided in accordance with statutory requirements via the specialist trade. Please submit or send faulty devices postage paid together with an error description to your responsible salesperson (specialist trade/installation company/electrical specialist trade). They will forward the devices to the Gira Service Center.

Gira
Giersiepen GmbH & Co. KG
Elektro-Installations-
Systeme

Industriegebiet Mermbach
Dahlienstraße
42477 Radevormwald

Postfach 12 20
42461 Radevormwald

Deutschland

Tel +49(0)21 95 - 602-0
Fax +49(0)21 95 - 602-191

www.gira.de
info@gira.de