

Universal Radio Cord Dimmer

Order No.: 0335 01

a)

**Function**

The Universal Radio Cord Dimmer permits radio-operated control of lighting fixtures.

The device permits switching (short actuation) or dimming (long actuation) of the lighting.

The dimmer is operated from a hand-held or wall-mounted radio control transmitter or from an extension unit. The universal radio control transmitter can only be used for switching of the cord dimmer.

The desired switch-on brightness can be stored (memory function).

On reception of a telegram from a programmed radio detector, the universal radio cord dimmer is switched on for ca. 1 min with the brightness level stored in memory.

The universal radio cord dimmer can be programmed to memorize up to 30 radio control transmitters.

b)

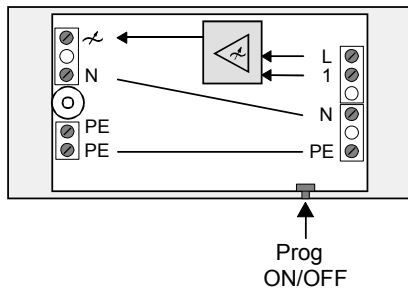
**Lightscapes**

The universal radio cord dimmer can be integrated into lightscape settings which can be activated with the hand-held or wall-mounted radio transmitter.

The device can store up to 5 different lightscapes.

ALL-ON / ALL-OFF

Depressing the ALL-ON (ALL-OFF) key of a memorized hand-held or wall-mounted radio transmitter switches the load on (off).

Fitting**Safety instructions**

Attention: Electrical equipment must be installed and fitted by qualified electricians only.

Not suitable for disconnecting.

Switching off the universal radio cord dimmer does not interrupt the common electrical connection existing between the load and the mains.

When using conventional transformers, each of these must be protected with a fuse on the primary side as specified in the manufacturer's instructions.

Only use safety transformers as per DIN VDE 0551.

Non-observance of the safety instructions may cause fire or other hazards.

c)

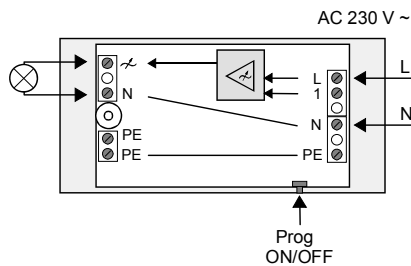

Installation

The distance to electrical loads (e. g. TRONIC transformer, electronic ballast, TV) must be at least 0.5 m.

Note the technical connection requirements issued by the power supply companies.

Centralized ripple-control signals injected by the power supply companies may cause short flickering when the dimmer is in low position.

Connect the universal radio cord dimmer as shown in fig. c).

Recommended cable type for effective pull relief: H 05 VV-F 3G 0,75

Automatic load detection

After first installation and after disconnection from the mains, the universal radio cord dimmer detects the load automatically.

Attention:

Do not connect capacitive loads (e. g. Tronic transformers) together with inductive loads (e. g. conventional transformers) to the universal radio cord dimmer.

When a mains failure of more than 0.7 sec. is detected, the dimmer will switch off.

With ohmic loads (incandescent and HV halogen lamps), the detection process causes short flickering of the lamps.

Depending on the mains condition, the detection lasts between 1 and 10 sec. During this time, the device does not accept any control commands. A short-circuit during the detection process requires redetection of the load after removal of the short-circuit.

Short-circuit protection

Phase cut-off operation (capacitive load, ohmic load)

The device shuts off and restarts automatically if the short-circuit condition is removed within 7 s. Otherwise, the universal cord dimmer remains permanently off until it is switched on again manually.

Phase cut-on operation (inductive load)

The device shuts off and restarts automatically if the short-circuit condition is removed within 100 ms. Otherwise, the universal cord dimmer remains permanently off until it is switched on again manually.

Over-temperature protection

The device is shut off when the ambient temperature is too high. After cooling down, the device must be switched on again.

Connected Load

The maximum connected load is 315 W/VA for:

- 230 V incandescent lamps, HV halogen lamps.
- LV halogen lamps with Tronic transformers
or
- LV halogen lamps with conventional transformers.
- Conventional transformers (The transformers must be operated with at least 85 % of their rated loads.

The total load including the transformer power loss must not exceed 315 W/VA.

The minimum connected load must be 50 W/VA.

d)

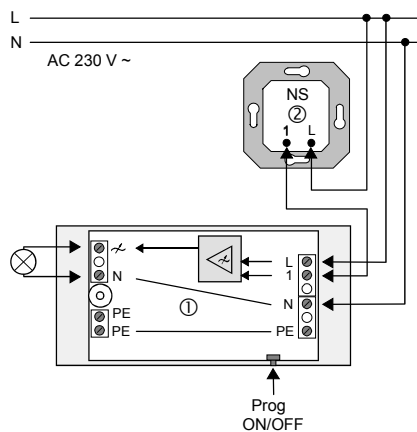

Control signal from extension unit

The universal cord dimmer (fig. d ①) can be operated with a System 2000 extension insert (fig. d ②). Connect one or more extension units to terminal 1 of the universal cord dimmer.

Installation push-buttons (with break or make contact) or mechanical extension units must not be connected to the cord dimmer.

e)

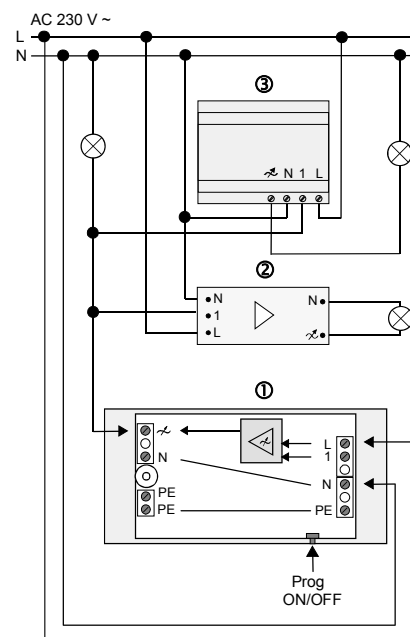

Power boost units

Depending on the load demanded from the universal cord dimmer, up to 10 boost units can be connected to the dimmer. Use Tronic power boost units (built-in or DRA types) in combination with Tronic transformers (capacitive loads).

Use LV power boost units (built-in or DRA types) in combination with conventional transformers (inductive loads).

Connect the boost units as shown in figure e:

- ①: universal cord dimmer
- ②: built-in power boost unit
- ③: DRA power boost unit

Programming a radio transmitter into the dimmer

When programming receivers to memorize transmitters, the sensitivity of the receivers is reduced to ca. 5 m. The distance between the universal radio cord dimmer and the radio transmitter to be memorized should therefore be between 0.5 m and 5 m.

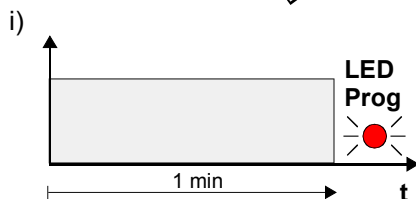
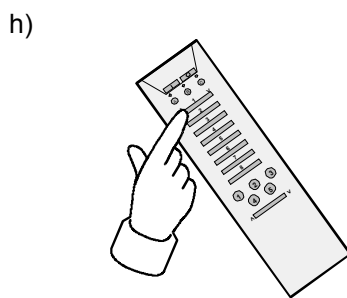
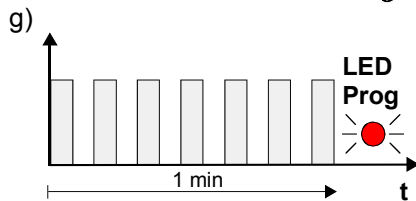
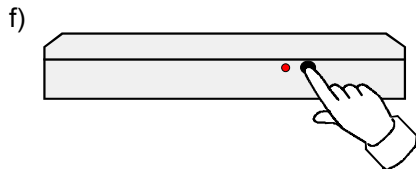

Programming procedure

1. Switch off the connected load by depressing the ON/OFF key for less than 1 s (fig. f).
2. Depress the ON/OFF key for ca. 4 s. The red LED flashes for ca. 1 min (fig. g). During this time, the device can be programmed to memorize a radio channel.
3. Start transmitting a radio telegram from the selected transmitter (fig.h); see Radio Transmitter operating instructions.
 - Memorizing a channel:**
depress the channel key for more than 1 s.
 - Memorizing a lightscape key:**
depress the lightscape key for more than 3 s.
 - Memorizing a radio detector:**
make a movement inside the detection range of the radio detector.
4. Successful programming is confirmed by the universal radio cord dimmer with the red LED (fig. i) being permanently lit.
5. The programming mode ends automatically after ca. 1 min or can be quitted by depressing the ON/OFF key (switching on the load). The universal radio cord dimmer is then in the operating mode.

Notes

- When all of the 30 memory locations are in use, one of the transmitters already assigned must be deleted if a new one is to be programmed.
- Memorizing a channel key automatically implies storing the ALL-ON key of the hand-held radio transmitter or the ALL-OFF key of the hand-held or wall-mounted radio transmitter as well.

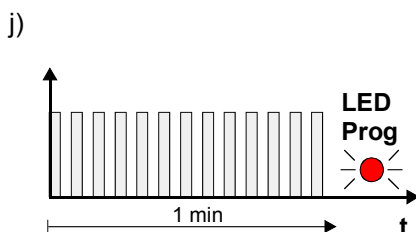

Clearing a transmitter from memory

A memorized radio transmitter can be deleted by programming a new one into the universal cord dimmer. Successful clearing is confirmed by a rapidly flashing red LED (fig. j).

Operation

The universal radio cord dimmer can be operated directly on the device or with a radio telegram received from a pre-programmed transmitter or by means of a System 2000 extension insert.

k)

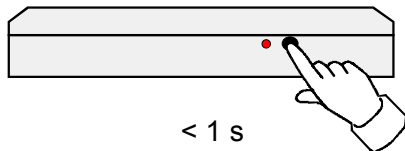

Operation on the device

Depressing the ON/OFF key for less than 1 s (fig. k) switches the universal radio cord dimmer permanently on or off.

Memory function

The preset dimming level (brightness) can be stored in the universal radio cord dimmer.

Programming

1. Switch on the lighting with the desired brightness.
2. Depress the ON/OFF key for at least 3 s. This action is confirmed by a soft start, i.e. the lights are switched off briefly and then brought up to the memory value.

Switching the lamp on next time by a short press on the key recalls this stored brightness value.

After delivery and in the event of a mains failure of more than 0.7 s, the memory value corresponds to maximum brightness.

Operation with a radio transmitter

Switching and dimming are performed with the hand-held or wall-mounted radio transmitter. The universal radio transmitter can only be used for switching of the universal radio cord dimmer.

When a memorized radio telegram is received from a radio detector, the universal cord dimmer is switched on for ca. 1 min with the memory brightness value.

Operation from extension units

The universal cord dimmer can also be switched on and off or dimmed with a System 2000 extension insert.

Short depression of key (< 0,4 s)

switches the lighting on, off or on with memory brightness value.

Long depression of key ($\geq 0,4$ s)

increases or reduces the brightness of the lighting.

Lightscape

The lightscape settings (brightness of lighting) are stored in the universal cord dimmer. A lightscape can be changed at any time by storing a new lightscape configuration.

Before storing or recalling a lightscape setting, one of the lightscape keys of a radio transmitter must have been programmed into the dimmer (see Radio Transmitter operating instructions).

Storing a lightscape setting

Procedure

1. Set the lighting to the desired brightness.
2. Depress the corresponding lightscape key of the radio transmitter for at least 3 s.

Note

The device starts by recalling first the old lightscape configuration (do not release the key). After ca. 3 s, the new lightscape setting is activated and stored.

Radio Transmission

l)

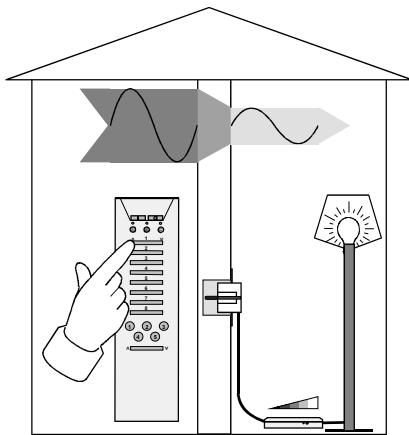

The radio signals are transmitted on non-exclusive frequencies. Transmission disturbances can therefore not be excluded.

The transmission by radio is not suitable for safety applications such as emergency shut-off and emergency calling functions.

The transmitting range of a radio transmitter (max. 100 m in free space) is dependent on local building conditions:

Dry Material	Permeability
Timber, gypsum, gypsum plaster boards	approx. 90 %
Brickwork, particle boards	approx. 70 %
Reinforced concrete	approx. 30 %
Metal, metal grating, aluminium sheeting	approx. 10 %

Technical specifications

Power supply voltage:	230 V AC, 50/60 Hz
Connected load:	50–315 VA - 230 V incandescent lamps (ohmic load, phase cut-off) - HV halogen lamps (ohmic load, phase cut-off) - TRONIC transformers (capacitive load, phase cut-off) or - Conventional transformers (inductive load, phase cut-on) - Mixed loads of the specified types (DO NOT mix capacitive with inductive loads).
	Do not exceed 50 % ohmic loading (incandescent, HV halogen lamps) when using mixed loads with conventional transformers.
Admissible number of power boost units:	max. 10
Spurious emissions:	acc. to EN 55015
Receiving frequency:	433.42 MHz, ASK
Telecom approval:	LPD-D
Protective system:	IP 20
Dimensions (LxWxH):	126 x 60 x 28 mm
Temperature range:	0 °C to +55 °C

Acceptance of guarantee

We accept the guarantee in accordance with the corresponding legal provisions.

Please return the unit postage paid to our central service department giving a brief description of the fault:

Gira
Giersiepen GmbH & Co. KG
Service Center
Dahlienstrasse 12
D-42477 Radevormwald



The CE sign is a free trade sign addressed exclusively to the authorities and does not include any warranty of any properties.

Gira
Giersiepen GmbH & Co. KG
Postfach 1220
D-42461 Radevormwald

Telefon: +49 / 21 95 / 602 - 0
Telefax: +49 / 21 95 / 602 - 339
Internet: www.gira.de