

Energy profile with three empty units,

height: 491 mm

1345 26/28

Energy profile with lighting element and three empty units,

height: 769 mm

1349 26/28

Energy profile with six empty units,

height: 769 mm

1351 26/28

GIRA

Table of contents

Device description	2
Device presentation	2
Setting up energy profile	3
Outfitting available device units.....	4
Connecting up energy profile	5
Installing/replacing light.....	5
Inserting slats	6
Technical data.....	6
Warranty.....	7

Device description

Energy profile for outdoors, made of powder-coated aluminium.

The available empty units can be outfitted as desired with all the functions from the TX_44 and System 55 switch design ranges, e.g. an automatic switch, a telephone jack or a loudspeaker connection.

The lighting element provides area and guiding illumination, e.g. in an entrance area.

The Gira energy profile is available in different versions in the colours anthracite and aluminium. Examples:

- Energy profile with three empty units, height: 491 mm
Order No. 1345 26/28
- Energy profile with lighting element and three empty units, height 769 mm
Order No. 1349 26/28
- Energy profile with six empty units, height: 769 mm
Order No. 1351 26/28

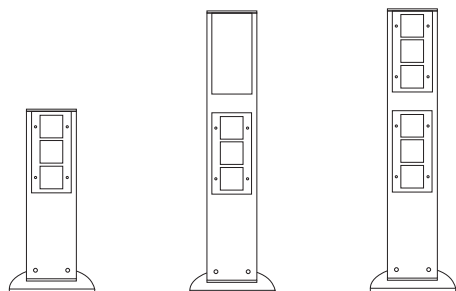

Device presentation

Here, the energy profile with a lighting element is used as an example for presentation of the basic energy profile design:

- (1) Cover
- (2) Lighting element with diffusing plate
- (3) Available device unit with TX_44 frame
- (4) Aluminium profile
- (5) Aluminium profile base

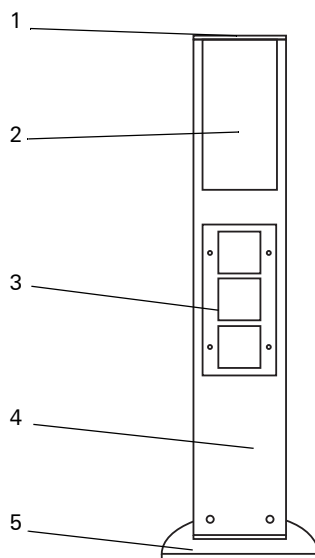

Notes on care

Please use only soap suds or a solvent-free, non-abrasive cleaning agent to clean the energy profile.

Setting up energy profile



Attention

The installation and assembly of electrical equipment may only be performed by a qualified electrician.

Condensation water opening

Before mounting the energy profile, open the condensation water drain on the bottom of the profile base. For this purpose, knock out the opening (see arrow) and remove the burr with a file.

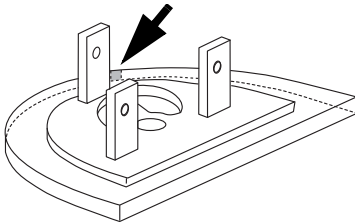

The energy profile is fastened with only one bolt. Depending on the conditions of the foundation, there are two options for anchoring the energy profile to the ground.

With an underground tube

The energy profile is set up using the underground tube on loose or soft ground, e.g. in flowerbeds or on grass.

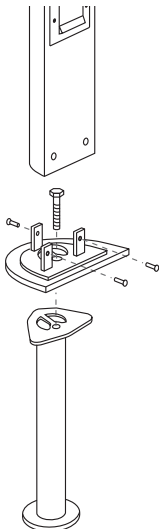

Position of the underground tube

Note the position of the energy column when cementing in the underground tube. It can be aligned by max. 20° on the underground tube.

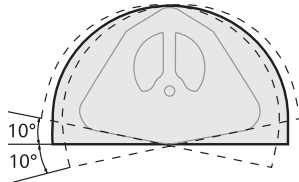

1. Dig a hole approx. 50 cm deep at the intended mounting site.
2. Guide the cables through the underground tube and cement the tube in vertically and flush with the surface.
3. Guide the cables through the profile base.
4. Mount the profile base to the underground tube with the accompanying hexagon bolt.
5. Guide the cables into the accompanying conduit boxes and connect the plastic-sheathed cables which reach the device units.
6. Connect the lighting element (if present) (see Page 5).
7. Connect the earth cable of the energy profile to the earth terminal of the profile base.
8. Place the energy profile on the profile base and fasten it with the three Allen bolts (M6 x 14).
9. For energy profiles with a lighting element, insert the light and close the profile with the cover.



Profile with no lighting element

For profiles with no lighting element, all devices and TX_44 cover frames must be mounted before the profile cover is set in place. To keep the profile splash-resistant, the top edge of the TX_44 cover frame must be flush with the top edge of the profile.

Screwing down directly

The energy profile can be set up directly on the ground on a solid base, e.g. a cement or asphalt surface.

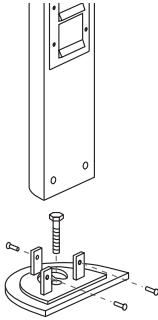

1. Drill a hole at the intended mounting location and insert the accompanying plug.
2. Guide the cables through the profile base and mount the base to the ground with the accompanying hexagon bolt.
3. Guide the cables into the accompanying conduit boxes and connect the plastic-sheathed cables which reach the device units.
4. Connect the lighting element (if present) (see Page 5).
5. Connect the earth cable of the energy profile to the earth terminal of the profile base.
6. Place the energy profile on the profile base and fasten it with the three Allen bolts (M6 x 14).
7. For energy profiles with a lighting element, insert the light and close the profile with the cover.



Profile with no lighting element

For profiles with no lighting element, all devices and TX_44 cover frames must be mounted before the profile cover is set in place. To keep the profile splash-resistant, the top edge of the TX_44 cover frame must be flush with the top edge of the profile.



Installation suggestion

Prepare the energy profile in your workshop: Install the devices and lay the corresponding plastic-sheathed cables in the conduit boxes. Then only the conduit boxes need be wired up on site.

The empty units of the energy profiles can be outfitted with components from the TX_44 or System 55 switch design ranges.



Integration of System 55 inserts

Inserts from System 55 must be installed via a TX_44 adapter plate with a hinged cover. An overview of the inserts which can be combined with each adapter plate is found in the current Gira catalogue.

Please install the flush-mounted inserts as follows:

1. Connect the device inserts.
2. Lay the connection lines in the conduit boxes.
3. Fit the inserts with the accompanying sealing pans. The profile has markings to which the supporting rings of the device can be aligned. This ensures that the frames are inserted later on in such a way which ensures splash resistance.
4. Set down the bottom section of the TX_44 frame and fasten it with the accompanying Phillips-head screws (B 3.5 x 16).
5. Fit the central inserts and screw them down if necessary.
6. Attach the adapter plates with a hinged cover if necessary.
7. Clip on the cover plate of the frame and press in the Torx screws.

Connecting up energy profile

Earth connection

Energy profiles with lighting elements and energy profiles which contain devices powered by 230 V must be earthed. The energy profiles have the following earth terminals:

- The lighting element is earthed via the terminal in the conduit box. The lighting element is also connected to the profile.
- An earth cable extends down to the profile base. Connect this cable to the profile base.
- If devices powered by 230 V are inserted into the empty units, the power profile must also be earthed. An additional earth terminal is available for this near the device unit. Connect this to the earth cable of the 230 V device.

Device connection

Due to the variability of the energy profile, all flush-mounted devices from the TX_44 or System 55 switch design range can be integrated. For this reason, please refer to the respective operating instructions accompanying each device for information on how each device is connected.

Lighting element connection

The lighting element of the energy profile is already pre-wired up to the connection terminal. Proceed as follows to connect the lighting element:

1. Remove the connection box from the lower opening of the energy profile and open it.
2. Connect the lighting element via the \otimes /N/ \oplus terminals.

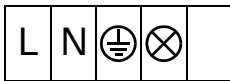

The available terminals can be used for the wiring of the empty units.

3. Close the connection box and push it back into the energy profile.

Installing/replacing light

Light sources with E27 threading of the energy efficiency classes A++ to E can be used.

To install or replace the light, proceed as follows:

1. Loosen both cover screws and remove the profile cover.
2. Pull the diffusing plate upward from the guide.
3. Insert the light.
4. Reinsert the diffusing plate from above (please note the "TOP FRONT" labelling).
5. Set the profile cover in place and fasten it with both cover screws.

Light diameter

Lamps with a base diameter of up to 52 mm can be used in the Energy Profile.

If a slats element is used, the maximum base diameter is reduced to 48 mm!

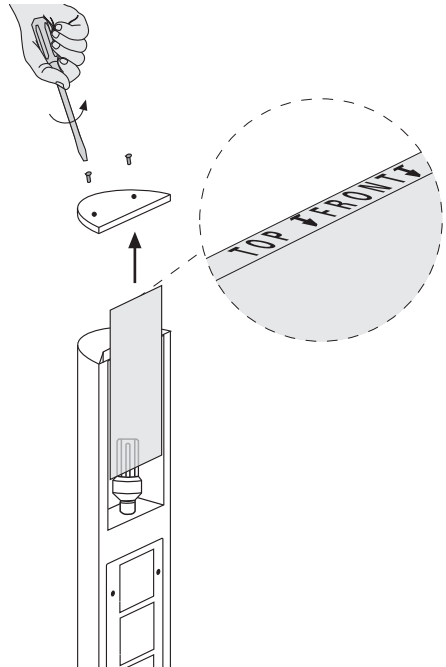

Inserting slats

Using the optionally available slats, the lighting element of the energy profile can be used for targeted object or path illumination.

To use the slat element and the accompanying transparent plate, proceed as follows:

1. Loosen both cover screws and remove the profile cover.
2. Pull the diffusing plate upward from the guide.
3. Insert the transparent plate from above (please note the "TOP FRONT" labelling).
4. Insert the slat element:
Slats directed upward,
e.g. for object illumination.

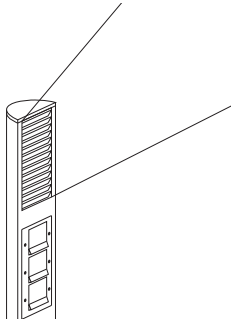

Slats directed downward,
e.g. for path illumination.

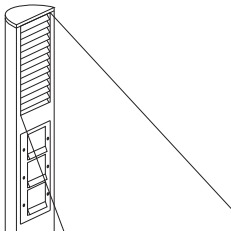

5. Set the profile cover in place and fasten it with both cover screws.

Technical data

Dimensions (W x H x D)

Profile base: 229 x 10 x 155 mm

Profile: 142 x 491 x 75 mm or

142 x 769 x 75 mm

Protection type: IP 44 with closed device covers

Connections: terminal screws 1 x 4 mm² or 2 x 2.5 mm²

Lamp: Light sources with E27
treading of the energy efficiency classes A++ to E
21 W max.

Power: 52 mm max.

Diameter: 48 mm max.

(if slats element is used)

Lit area

Energy profile with lighting element, height
769 mm, frosted diffusing plate, 20 W

Height of point of light above ground: 0,65 m

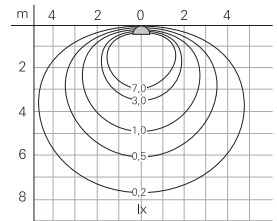

Transparent plate/diffusing plate

The slat element can be used with either the transparent plate or the frosted diffusing plate.

Warranty

The warranty is provided in accordance with statutory requirements via the specialist trade.

Please submit or send faulty devices postage paid together with an error description to your responsible salesperson (specialist trade/ installation company/electrical specialist trade).

They will forward the devices to the Gira Service Center.

Gira
Giersiepen GmbH & Co. KG
Electrical installation
systems
Industriegebiet Mermbach
Dahlienstraße
42477 Radevormwald
P.O. Box 12 20
42461 Radevormwald
Germany
Phone+49 (0) 2195 602 - 0
Fax +49 (0) 2195 602 - 191
www.gira.com
info@gira.com

10866543 49/19

GIRA

