

Switching actuator, 6-gang / blind actuator, 3-gang Standard

Order no.: 5023 00

Switching actuator, 16-gang / blind actuator, 8-gang Standard

Order no.: 5028 00

Switching actuator, 24-gang / blind actuator, 12-gang Standard

Order no.: 5030 00

Switching actuator, 6-gang / blind actuator, 3-gang Komfort

Order no.: 5033 00

Switching actuator, 16-gang / blind actuator, 8-gang Komfort

Order no.: 5038 00

Switching actuator, 24-gang / blind actuator, 12-gang Komfort

Order no.: 5040 00

Operating instructions

1 Safety instructions



Electrical devices may only be mounted and connected by electrically skilled persons.

Serious injuries, fire or property damage possible. Please read and follow manual fully.

The device may not be opened or operated outside the technical specifications.

Danger of electric shock. Device is not suitable for disconnection from supply voltage.

Danger of electric shock on the SELV/PELV installation. Do not connect loads for mains voltage and SELV/PELV together to the device.

For parallel connection of several motors to an output it is essential to observe the corresponding instructions of the manufacturers, and to use a cut-off relay if necessary. The motors may be destroyed.

Use only venetian blind motors with mechanical or electronic limit switches. Check the limit switches for correct adjustment. Observe the specifications of the motor manufacturers. Device can be damaged.

Do not connect any three-phase motors. Device can be damaged.

These instructions are an integral part of the product, and must remain with the end customer.

2 Device components

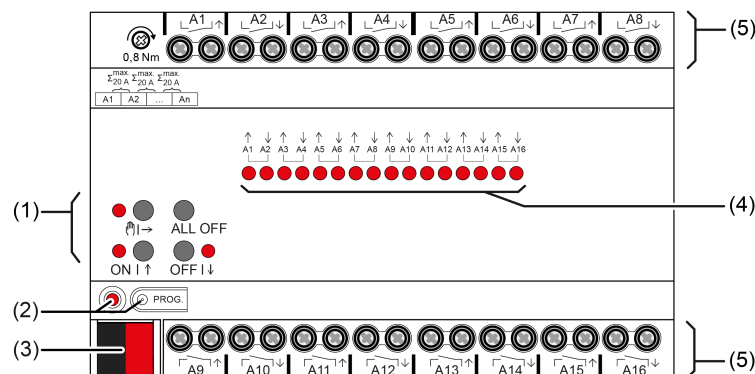

Figure 1: Device components

- (1) Button field for manual operation
- (2) Programming button and LED
- (3) KNX connection

- (4) Status LEDs for outputs
- (5) Load connections (relay outputs)

3 Function

System information

This device is a product of the KNX system and complies with the KNX directives. Detailed technical knowledge obtained in KNX training courses is a prerequisite to proper understanding.

The function of this device depends upon the software. Detailed information on loadable software and attainable functionality as well as the software itself can be obtained from the manufacturer's product database.

The device can be updated. Firmware can be easily updated with the Gira ETS Service App (additional software).

The device is KNX Data Secure capable. KNX Data Secure offers protection against manipulation in building automation and can be configured in the ETS project. Detailed specialist knowledge is required. A device certificate, which is attached to the device, is required for safe commissioning. During mounting, the certificate must be removed from the device and stored securely.

Planning, installation and commissioning of the device are carried out with the aid of the ETS, version 5.7.3 and above.

Intended use

- Switching of electrical loads with potential-free contacts
- Switching of electrically-driven Venetian blinds, roller shutters, awnings and similar hangings
- Mounting on DIN rail according to EN 60715 in small distribution boards

Product characteristics

- Outputs can be operated manually, construction site mode
- Feedback in manual mode and in bus mode
- Disabling of individual outputs manually or by bus
- Status feedback (e. g. wind alarm)
- KNX Data Secure compatible
- Updateable with Gira ETS Service App

Characteristics switch operation

- Operation as NO or NC contacts
- Feedback function
- Logic and restraint function
- Central switching functions with collective feedback
- Time functions: switch-on delay, switch-off delay, staircase lighting timer with run-on time
- Scene function
- Operating hours counter

Characteristics blinds operation

- Suitable for AC motors 110...230 V
- Operating modes "Venetian blind with slats", "Roller shutter/awning", "Venting louver/roof window"
- Blind/shutter position directly controllable
- Slat position directly controllable
- Feedback of movement status, blind/shutter position and slat position
- Forced position through higher-level controller
- Safety function: 3 independent wind alarms, rain alarm, frost alarm

- Sun protection function with heating/cooling operation
- Disabling function (lock-out protection)
- Scene function

Logic function characteristics

- Logic gates
- Transformer (conversion)
- Disabling element
- Comparator
- Limit value switch

4 Operation

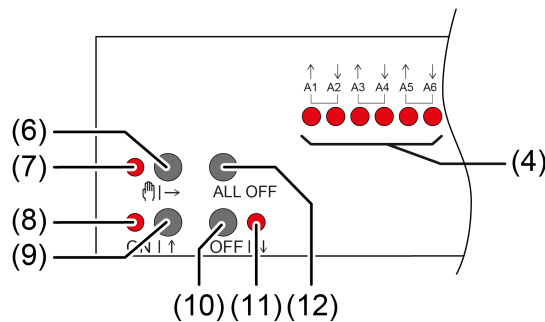

Figure 2: Operating elements

- (4) Status LEDs for outputs
ON: Relay output closed
OFF: Relay output opened
Flashes slowly: output in manual mode selected
Flashes quickly: Output disabled via continuous manual mode
- (6) Button | →
Manual operation
- (7) LED | →
ON: continuous manual mode active / Flashing: temporary manual control active
- (8) LED **ON** | ↑
ON: relay outputs closed, manual operation active
- (9) Button **ON** | ↑
Short: switch on, adjust slats or stop.
Long: Move hanging upwards
- (10) Button **OFF** | ↓
Short: switch off, adjust slats or stop.
Long: Move hanging downwards.
- (11) LED **OFF** | ↓
ON: relay outputs open, manual control active
- (12) Button **ALL OFF**
Open all relay outputs, stop drives

In operation with the button field the device distinguishes between a short and a long press.

- Short: actuation for less than 1 s
- Long: actuation of between 1 and 5 s

In switching operation, the device distinguishes between the operating modes "normally open contact" and "normally closed contact". The buttons (9 + 10) change the switching status when pressed:

Normally open contact: switch on = close relay, switch off = open relay
 Normally closed contact: switch on = open relay, switch off = close relay
 The LEDs (4 + 8 + 11) always indicate the relay status.

- i** The LEDs (4) optionally indicate the status of the outputs only temporarily (depending on the parameters).

Operating modes

- Bus operation: Operation via push-button sensors or other bus devices
- Temporary manual control: manual control locally with keypad, automatic return to bus control
- Continuous manual mode: Exclusively manual operation on the device

- i** No bus operation is possible in manual mode.

- i** After a bus failure and restoration the device switches to bus operation.

- i** The manual mode can be disabled in ongoing operation via a bus telegram.

Switching on the temporary manual control

Operation using the button field is programmed and not disabled.

- Press button \rightarrow (6) briefly.
 LED \rightarrow (7) flashes, LEDs A1... (4) of the first configured output or output pair flash.
 Short-time manual operation is switched on.

- i** After 5 s without a key-press, the actuator returns automatically to bus operation.

Switching off temporary manual operation

The device is in short-term manual mode.

- No button-press for 5 s.
 - or -
- Press \rightarrow (6) button briefly as many time as necessary until the actuator leaves the short-time manual mode.

Status LEDs A1... (4) no longer flash, but rather indicate the relay status.

Short-time manual operation is switched off.

Switching outputs: depending on the programming, the output relays switch to the position that is active after the manual mode is switched off, e.g. to the forced position, logic function.

Blind/shutter outputs: depending on the programming, the hangings move to the position that is active after the manual mode is switched off, e.g. to the forced position, safety or sun protection position.

Switching on permanent manual control

Operation using the button field is programmed and not disabled.

- Press the \rightarrow (6) button for at least 5 s.
 LED \rightarrow (7) lights up, LEDs A1... (4) of the first configured output or output pair flash.
 Continuous manual mode is switched on.

Switching off permanent manual control

The device is in continuous manual mode.

- Press the \rightarrow (6) button for at least 5 s.
 LED \rightarrow (7) is off.

Continuous manual mode is switched off. Bus operation is switched on.

Switching outputs: depending on the programming, the output relays switch to the position that is active after the manual mode is switched off, e.g. to the forced position, logic function.

Blind/shutter outputs: depending on the programming, the hangings move to the position that is active after the manual mode is switched off, e.g. to the forced position, safety or sun protection position.

Operating an output in manual mode

- Activate short-term or permanent manual operation.
- Press button  (1) repeatedly until LED **A1...** (4) of the desired output or output pair flashes.
- Press button **ON**|↑ (9) or **OFF**|↓ (10).
Short: Switch on/off, drive stop
Long: Move blind/shutter upwards/downwards
LED **ON**|↑ (3) ON: Relay output closed
LED **OFF**|↓ (6) OFF: Relay output opened

 Short-term manual operation: After running through all of the outputs the device exits manual mode after another brief press.

Switching off all outputs / Stopping all hangings

The device is in continuous manual mode.

- Press the **ALL OFF** button (7).
Switching outputs: All outputs switch off (NO operating mode: relay output opened/NC operating mode: relay output closed).
Venetian blind outputs: All blinds/shutters stop.

Disabling outputs

The device is in continuous manual mode. The bus control can be disabled (ETS parameter).

- Press button  (6) repeatedly until LED **A1...** (4) of the desired output or output pair flashes.
- Press the/ **ON**|↑ (9) and / **OFF**|↓ (10) buttons simultaneously for approx. 5 s.
Selected output is disabled.
The status LED **A1...** (4) of the selected output or output pair flashes quickly.

 A disabled output can be operated in manual mode.

Re-enabling outputs

The device is in continuous manual mode. One or more outputs were disabled in manual mode.

- Press button  (6) repeatedly until the output to be unlocked or the output pair is selected.
- Press the/ **ON**|↑ (9) and / **OFF**|↓ (10) buttons simultaneously for approx. 5 s.
Disabling is deactivated.
The LED **A1...** (4) of the selected output or output pair flashes slowly.

5 Information for electrically skilled persons



DANGER!

Mortal danger of electric shock.

Disconnect the device. Cover up live parts.

5.1 Fitting and electrical connection

Fitting the device

In secure operation (preconditions):

- Secure commissioning is activated in the ETS.
- Device certificate entered/scanned or added to the ETS project. A high resolution camera should be used to scan the QR code.
- Document all passwords and keep them safe.

Observe ambient temperature. Ensure adequate cooling.

- Mount device on DIN rail.
- In secure operation: The device certificate must be removed from the device and stored securely.

Connecting the device

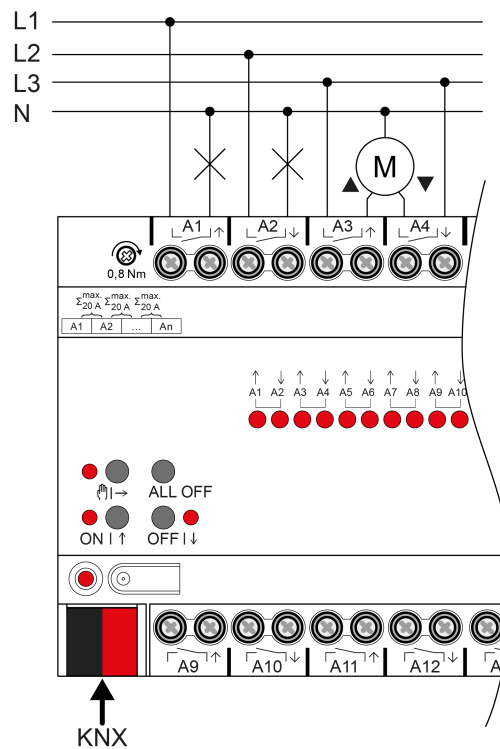

Figure 3: Device connection (connection example):

- Connect bus line with KNX connecting terminal according to their correct polarity.
- Attach the cover cap to the KNX connection as protection against hazardous voltages.
- Connect load as shown in the connection example. Two adjacent relay outputs form a Venetian blind output.

The total current capacity of neighbouring outputs is a maximum of 20 A.

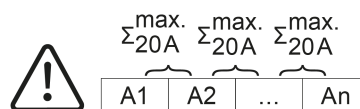

Figure 4: Total current capacity of neighbouring outputs

5.2 Commissioning

Commissioning the device



NOTICE!

Incorrect load control due to undefined relay state at delivery.

Risk of destruction of connected drive motors.

During commissioning, before switching on the load, ensure that all relay contacts are open by applying the KNX bus voltage. Observe commissioning sequence!

- Switch on the KNX bus voltage.
 - Wait about 10 s.
 - Switch on load circuits.
- i** Delivery state: The outputs can be operated with manual control. Outputs are set as venetian blind outputs.

Load physical address and application program

- For switched loads, configure the outputs as a switching output.
- For Venetian blind operation, configure the outputs as a Venetian blind output.
- In Venetian blind operation: measure blind/shutter and slat travel times and enter them in the parameter setting.
- Press the programming button.
The programming LED lights up.
- Load physical address and application program using the ETS.

Safe-state mode

The safe state mode stops the execution of the loaded application program.

- i** Only the system software of the device is still functional. ETS diagnosis functions and programming of the device are possible. Manual operation is not possible.

Activating the safe-state mode

- Switch off the bus voltage or remove the KNX device connection terminal.
- Wait about 15 s.
- Press and hold down the programming button.
- Switch on the bus voltage or attach the KNX device connection terminal. Release the programming button only after the programming LED starts flashing slowly.
The safe-state mode is activated.

With a new brief press of the programming button, the programming mode can be switched on and off as usual also in the safe-state mode. If Programming mode is active, the programming LED stops flashing.

Deactivating safe-state mode

- Switch off bus voltage (wait approx. 15 s) or carry out ETS programming.

Master reset

The master reset restores the basic device setting (physical address 15.15.255, firmware remains in place). The device must then be recommissioned with the ETS. Manual operation is possible.

During secure operation: A master reset deactivates device security. The device can then be recommissioned with the device certificate.

Performing a master reset

Precondition: The safe-state mode is activated.

- Press and hold down the programming button for > 5 s.
The programming LED flashes quickly.
The device performs a master reset, restarts and is ready for operation again after approx. 5 s.

Restoring the device to factory settings

Devices can be reset to factory settings with the Gira ETS Service App. This function uses the firmware contained in the device that was active at the time of delivery (delivery state). Restoring the factory settings causes the devices to lose their physical address and configuration.

6 Technical data

Ambient conditions	
Ambient temperature	-5 ... +45 °C
Storage/transport temperature	-25 ... +70 °C
KNX	
KNX medium	TP256
Commissioning mode	S-mode
Rated voltage KNX	DC 21 ... 32 V SELV
Current consumption KNX	
Order no. 5023 00, 5028 00, 5033 00, 5038 00	5 ... 18 mA
Order no. 5030 00, 5040 00	5 ... 24 mA
Outputs	
Switching voltage	AC 250 V ~
Switching current AC1	16 A
Fluorescent lamps	16 AX
Current carrying capacity	
Neighbouring outputs	Σ 20 A
Loads per output	
Ohmic load	3000 W
Capacitive load	max. 16 A (140 µF)
Motors	1380 VA
Switch-on current 200 µs	max. 800 A
Switch-on current 20 ms	max. 165 A
Lamp loads	
Incandescent lamps	2300 W
HV halogen lamps	2300 W
HV-LED lamps	max. 400 W
LV halogen lamps with electronic transformers	1500 W
LV halogen lamps with inductive transformer	1200 VA
Compact fluorescent lamps	
uncompensated	1000 W
parallel compensated	1160 W (140 µF)
Fitting width	

Order no. 5023 00, 5033 00	72 mm / 4 module
Order no. 5028 00, 5038 00	144 mm / 8 module
Order no. 5030 00, 5040 00	216 mm / 12 module
Weight	
Order no. 5023 00, 5033 00	approx. 230 g
Order no. 5028 00, 5038 00	approx. 500 g
Order no. 5030 00, 5040 00	approx. 740 g
Clampable conductor cross-section	
single stranded	0.5 ... 4 mm ²
Finely stranded without conductor sleeve	0.5 ... 4 mm ²
Finely stranded with conductor sleeve	0.5 ... 2.5 mm ²
Connection torque screw terminals	Max. 0.8 Nm

7 Warranty

The warranty is provided in accordance with statutory requirements via the specialist trade. Please submit or send faulty devices postage paid together with an error description to your responsible salesperson (specialist trade/installation company/electrical specialist trade). They will forward the devices to the Gira Service Center.

Gira
Giersiepen GmbH & Co. KG
Elektro-Installations-
Systeme

Industriegebiet Mermbach
Dahlienstraße
42477 Radevormwald

Postfach 12 20
42461 Radevormwald

Deutschland

Tel +49(0)21 95 - 602-0
Fax +49(0)21 95 - 602-191

www.gira.de
info@gira.de