

Switching actuator, 1-gang 16 A with binary input,
3-gang
Order no. 5061 00



Table of Contents

| | | |
|----------|--|-----------|
| 1 | Information on the product | 5 |
| 1.1 | Product catalogue | 5 |
| 1.2 | Function | 5 |
| 1.3 | Device components | 7 |
| 1.4 | Technical data..... | 8 |
| 1.5 | Accessories..... | 10 |
| 2 | Safety instructions | 11 |
| 3 | Fitting and electrical connection | 12 |
| 4 | Commissioning | 15 |
| 5 | Application programs | 17 |
| 6 | Scope of functions | 18 |
| 7 | Notes on software | 21 |
| 8 | Relay output | 22 |
| 8.1 | Priorities | 22 |
| 8.2 | General settings..... | 23 |
| 8.2.1 | Reset behaviour | 23 |
| 8.2.2 | Central functions..... | 24 |
| 8.2.3 | Name of switching output | 28 |
| 8.3 | Operating mode | 29 |
| 8.3.1 | Operating mode parameters..... | 30 |
| 8.3.2 | Operating mode objects | 30 |
| 8.4 | Reset and initialisation behaviour | 31 |
| 8.4.1 | Reset and initialisation behaviour parameter | 34 |
| 8.5 | Cyclical monitoring..... | 36 |
| 8.5.1 | Cyclical monitoring parameters | 37 |
| 8.6 | Feedback switching status..... | 38 |
| 8.6.1 | Feedback switching status parameters | 42 |
| 8.6.2 | Feedback switching status objects | 45 |
| 8.7 | Time delays..... | 46 |
| 8.7.1 | Time delays parameters | 47 |
| 8.8 | Staircase function | 48 |
| 8.8.1 | Staircase function parameters | 55 |
| 8.8.2 | Staircase function objects..... | 59 |
| 8.9 | Scene function | 60 |
| 8.9.1 | Scene function parameters..... | 65 |

| | | |
|----------|---|-----------|
| 8.9.2 | Scene function objects | 67 |
| 8.10 | Disabling function and forced position | 68 |
| 8.10.1 | Disabling function and forced position parameters | 71 |
| 8.10.2 | Disabling function and forced position objects | 75 |
| 8.11 | Logic operation function | 76 |
| 8.11.1 | Logic operation function parameters | 78 |
| 8.11.2 | Logic operation function objects | 78 |
| 8.12 | Operating hours counter | 79 |
| 8.12.1 | Operating hours counter parameters | 84 |
| 8.12.2 | Operating hours counter objects | 87 |
| 9 | Inputs | 89 |
| 9.1 | General settings | 89 |
| 9.1.1 | Configuration inputs parameters | 93 |
| 9.2 | Switching | 96 |
| 9.2.1 | Switching parameters | 96 |
| 9.2.2 | Switching objects | 97 |
| 9.3 | Dimming | 98 |
| 9.3.1 | Dimming of brightness | 99 |
| 9.3.2 | Dimming of colour temperature | 99 |
| 9.3.3 | Dimming of brightness and colour temperature | 100 |
| 9.3.4 | Dimming parameters | 101 |
| 9.3.5 | Dimming objects | 105 |
| 9.4 | Venetian blind | 106 |
| 9.4.1 | Shutter/blind parameters | 110 |
| 9.4.2 | Shutter/blinds objects | 112 |
| 9.5 | Value transmitter | 113 |
| 9.5.1 | 1-byte value transmitter | 116 |
| 9.5.2 | 2-byte value transmitter | 116 |
| 9.5.3 | 3-byte value transmitter | 117 |
| 9.5.4 | 6-byte value transmitter | 120 |
| 9.5.5 | Value transmitter parameters | 121 |
| 9.5.6 | Value transmitter objects | 129 |
| 9.6 | Scene extension | 134 |
| 9.6.1 | Scene extension parameters | 135 |
| 9.6.2 | Scene extension objects | 135 |
| 9.7 | 2-channel operation | 136 |
| 9.7.1 | 2-channel operation parameters | 138 |
| 9.7.2 | 2-channel operation objects | 144 |

| | | |
|-----------|--|------------|
| 9.8 | Controller extension | 151 |
| 9.8.1 | Operating mode switchover | 152 |
| 9.8.2 | Presence function | 153 |
| 9.8.3 | Setpoint shift | 154 |
| 9.8.4 | Controller extension parameters | 156 |
| 9.8.5 | Controller extension objects | 159 |
| 9.9 | Temperature measurement | 161 |
| 9.9.1 | Temperature measurement parameters | 164 |
| 9.9.2 | Temperature measurement objects | 166 |
| 9.10 | Disabling functions | 167 |
| 9.10.1 | Disabling functions parameters | 171 |
| 9.10.2 | Disabling functions objects | 174 |
| 10 | Logic functions | 175 |
| 10.1 | Logic functions parameters | 176 |
| 10.2 | Logic gates | 178 |
| 10.2.1 | Logic gate parameters | 180 |
| 10.2.2 | Logic gate objects | 183 |
| 10.3 | Converter (1 bit -> 1 byte) | 185 |
| 10.3.1 | Converter parameters | 186 |
| 10.3.2 | Converter objects | 188 |
| 10.4 | Disabling element [Filtering/Time] | 189 |
| 10.4.1 | Disabling element parameters | 191 |
| 10.4.2 | Disabling element objects | 195 |
| 10.5 | Comparator | 196 |
| 10.5.1 | Comparator parameters | 198 |
| 10.5.2 | Comparator objects | 204 |
| 10.6 | Limit value switch | 207 |
| 10.6.1 | Limit value switch parameters | 209 |
| 10.6.2 | Limit value switch objects | 215 |
| 11 | Delivery state | 218 |

1 Information on the product

1.1 Product catalogue

| | |
|---------------|---|
| Product name: | Switching actuator, 1-gang 16 A with binary input, 3-gang |
| Use: | Actuator |
| Design: | FM |
| Order no. | 5061 00 |

1.2 Function

The switch actuator receives telegrams from sensors or other controls via the KNX and switches an electrical load. The functionalities include NC contact or NO contact, for example, extensive time functions, logic operations, scenes, monitoring functions, operating hours counters, disabling functions or alternatively forced positions. In addition, the switching status of a relay output can be signaled back. The central switching operation of the switching outputs of up to 6 central functions is possible, too.

Besides the relay output, the device possesses three additional inputs. Potential-free switches, push-buttons or other contacts (e.g. magnetic contacts) or alternatively leakage and dew sensors (accessories) can be connected to these inputs. In addition, it is possible to connect an NTC temperature sensor to input 3 for measuring a floor or room temperature. The signals of the inputs are read in via a common reference potential on the device.

Depending on the ETS parameterisation in the application for switches, push-buttons or contacts, the inputs 1 and 2 either act internally on the relay output or alternatively also separately on the KNX. Input 3 always acts on the KNX if required. With internal action, inputs 1 and 2 directly operate the switching output in a defined configuration. With the effect on the KNX, the inputs can transmit individual telegrams for switching or dimming for venetian blind control or value transmitter use (dimming value transmitter, light scene extension, colour or colour temperature value transmitter).

In addition to the switching operation and to the inputs, the device has 8 internal logic functions. Using these functions, logic gates (e.g. AND, OR, exclusive OR, each with up to 4 inputs) can be set up and thus switching and status information can be linked and evaluated. Alternatively, a 1-bit to 1-byte converter and a disabling element with filter and time functions can be configured for each logic function. As a further option, comparators or limit value switches with hysteresis can be set as a logic function. The logic functions have their own KNX communication objects and can process telegrams of the actuator or of other bus devices.

The device can be updated. Firmware can be easily updated with the Gira ETS Service App (additional software).

The device is KNX Data Secure capable. KNX Data Secure offers protection against manipulation in building automation and can be configured in the ETS project. Detailed specialist knowledge is required. A device certificate, which is attached to the device, is required for safe commissioning. During mounting, it is recommended to remove the certificate from the device and to store it securely.

Planning, installation and commissioning of the device are carried out with the aid of the ETS, version 5.7.3 and above or of the ETS6.

The device electronics are supplied exclusively from the bus voltage. The device is designed for installation in suitable flush-mounted appliance boxes (recommendation: electronic device box with partition).

1.3 Device components

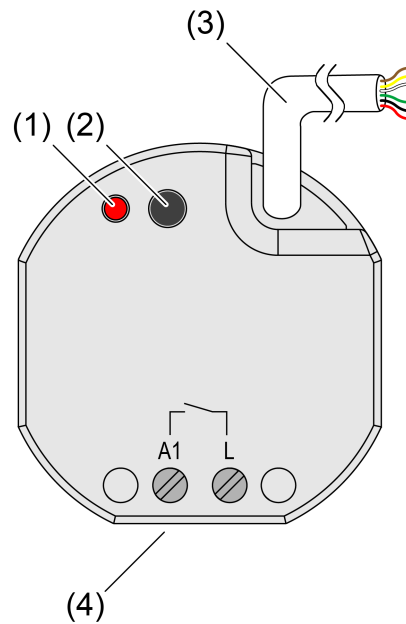

Image 1: Device components

- (1) Programming LED
- (2) Programming button
- (3) Control cable (KNX connection and extension inputs)
- (4) Load connection (relay output)

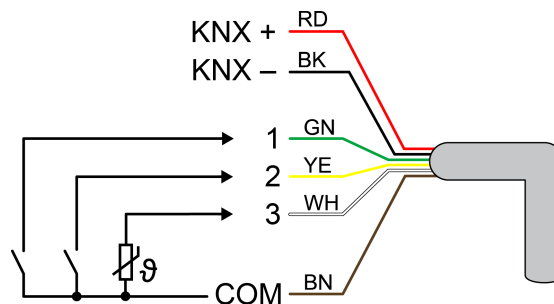

Image 2: Connection assignment of control cable (example)

- | | |
|-------------|--|
| red (RD) | KNX + |
| black (BK) | KNX - |
| green (GN) | Input 1 (push-button, switch, contact, dew/leakage sensor) |
| yellow (YE) | Input 2 (push-button, switch, contact, dew/leakage sensor) |
| white (WH) | Input 3 (push-button, switch, contact, dew/leakage sensor, NTC temperature sensor) |
| brown (BN) | COM inputs 1...3 |

1.4 Technical data**Ambient conditions**

| | |
|-------------------------------|-----------------|
| Ambient temperature | -5 ... +45 °C |
| Storage/transport temperature | -25 ... +70 °C |
| Dimensions (W × H × D) | 48 x 50 x 28 mm |

KNX

| | |
|-------------------------|--------------------------------------|
| KNX medium | TP256 |
| Commissioning mode | S-mode |
| Rated voltage KNX | DC 21 ... 32 V SELV |
| Current consumption KNX | 5 ... 18 mA |
| Connection mode KNX | Connection terminal on control cable |

Outputs

| | |
|--------------------------|-----------------|
| Connection mode | Screw terminals |
| Switching voltage | AC 250 V ~ |
| Switching current | 16 AX |
| Switch-on current 200 µs | max. 800 A |
| Switch-on current 20 ms | max. 165 A |

Connected load

| | |
|--|--------------------|
| Ohmic load | 2500 W |
| Capacitive load | max. 16 A (140 µF) |
| Motors | 1380 VA |
| Incandescent lamps | 2300 W |
| HV halogen lamps | 2300 W |
| HV-LED lamps | max. 400 W |
| LV halogen lamps with electronic transformers | 1500 W |
| LV halogen lamps with inductive transformer | 1200 VA |
| Compact fluorescent lamps uncompensated | 1000 W |
| Compact fluorescent lamps parallel compensated | 1160 W (140 µF) |

Reduction of connected load

| | |
|--|------|
| per 5 °C in excess of 35 °C | -10% |
| when installed in wooden or dry construction walls | -15% |
| when installed in multiple combinations | -20% |

Clampable conductor cross-section

| | |
|--|---------------------------|
| single stranded | 0.5 ... 4 mm ² |
| Finely stranded without conductor sleeve | 0.5 ... 4 mm ² |

| | |
|--|-----------------------------|
| Finely stranded with conductor sleeve | 0.5 ... 2.5 mm ² |
| Connection torque screw terminals | Max. 0.8 Nm |
| Inputs | |
| Control cable (preterminated) | YY6x0.6 |
| Input type | Potential-free |
| Number | 3 |
| Total length of extension device cable | max. 10 m |
| Cable type (preferably) | J-Y(St)Y |
| Poll voltage, extension inputs | approx. 5 V |

1.5 Accessories

| | |
|--|---------|
| Remote sensor (NTC temperature sensor) | 1493 00 |
| Condensation sensor | 5069 00 |
| Leakage sensor | 5068 00 |

2 Safety instructions



Electrical devices may only be mounted and connected by electrically skilled persons.

Serious injuries, fire or property damage possible. Please read and follow manual fully.

The device may not be opened or operated outside the technical specifications.

Danger of electric shock. Device is not suitable for disconnection from supply voltage.

Danger of electric shock. Make sure during the installation that there is always sufficient insulation between the mains voltage and the bus. A minimum distance of at least 4 mm must be maintained between bus conductors and mains voltage cores.

Danger of electric shock on the KNX installation. Do not connect any external voltage to the inputs. The device might be damaged, and the SELV potential on the KNX bus line will no longer be available.

These instructions are an integral part of the product, and must remain with the end customer.

3 Fitting and electrical connection



DANGER!

Mortal danger of electric shock.

Disconnect the device. Cover up live parts.



DANGER!

When connecting the bus/extensions and mains voltage wires in a shared appliance box, the KNX bus line may come into contact with the mains voltage.

This endangers the safety of the entire KNX installation. People at remote devices may also receive an electric shock.

Do not place bus/extensions and mains voltage terminals in a shared connection compartment. Use an appliance box with a fixed partition wall or separate appliance boxes.

Connecting and fitting the device

In secure operation (preconditions):

- Secure commissioning is activated in the ETS.
- Device certificate entered/scanned or added to the ETS project. A high resolution camera should be used to scan the QR code.
- Document all passwords and keep them safe.

Mounting in suitable appliance box (recommendation: electronic device box with partition). Observe cable routing and spacing (see figure 3)!

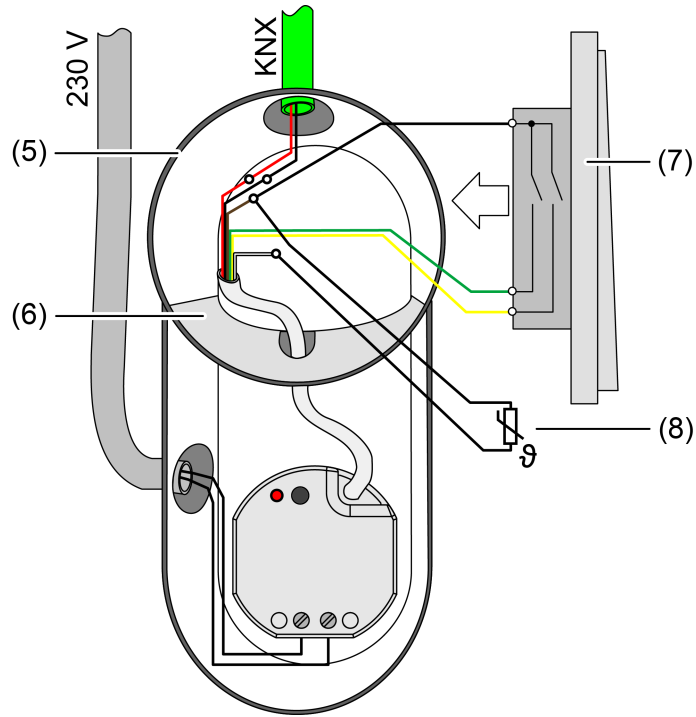

Image 3: Mounting example in electronic device box with partition wall, series push-button and NTC temperature sensor

- (5) Appliance box
- (6) Partition
- (7) potential-free contacts (e.g. series push-button)
- (8) NTC temperature sensor (optional)

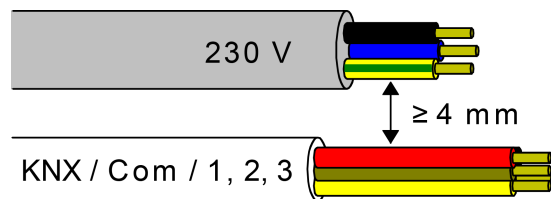

Image 4: Cable spacing

Minimum spacing between the mains voltage and bus/extension wires: 4 mm (see figure 4)

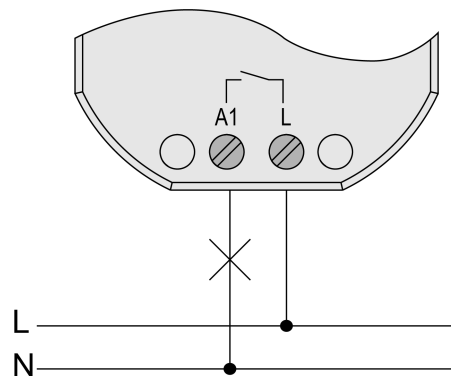

Image 5: Connection of load

Observe ambient temperature. Ensure adequate cooling.

- Connect the device to KNX with the correct polarity.
- Connect load as shown in the connection example (see figure 5).
- If required, connect potential-free contacts or dew/leakage sensors to inputs 1...3, or NTC temperature sensors to input 3 (see figure 2).
- Install the device in the appliance box.
- In secure operation: The device certificate must be removed from the device and stored securely.

i The COM reference potential must not be connected together with COM connections of other devices!

i Only use the dew/leakage sensors and NTC temperature sensors listed in the accessories. Functional errors may occur with other sensors.

4 Commissioning

Commissioning the device



NOTICE!

Undefined relay state at delivery.

Unexpected control of connected loads.

During commissioning, before switching on the load, ensure that all relay contacts are open by applying the KNX bus voltage. Observe commissioning sequence!

- Switch on the KNX bus voltage.
- Wait about 10 s.
- Connect the load circuit.

i Delivery state: Operation of the output via switch at input 1 (ON / OFF) possible. Inputs 2 and 3 have no function.

| Input | Switch | Function |
|-------|--------|----------|
| 1 | closed | ON |
| 1 | open | OFF |
| 2 | --- | --- |
| 3 | --- | --- |

Table 1: Function of Inputs in the as-delivered state

Load physical address and application program

- Press the programming button.
The programming LED lights up.
- Load physical address and application program using the ETS.

Safe-state mode

The safe state mode stops the execution of the loaded application program.

i Only the system software of the device is still functional. ETS diagnosis functions and programming of the device are possible.

Activating the safe-state mode

- Switch off the bus voltage or disconnect the device from the KNX.
- Wait about 10 s.
- Press and hold down the programming button.
- Switch on the bus voltage or connect the device to KNX. Release the programming button only after the programming LED starts flashing slowly.
The safe-state mode is activated.

With a new brief press of the programming button, the programming mode can be switched on and off as usual also in the safe-state mode. If Programming mode is active, the programming LED stops flashing.

Deactivating safe-state mode

- Switch off bus voltage (wait approx. 10 s) or carry out ETS programming.

Master reset

The master reset restores the basic device setting (physical address 15.15.255, firmware remains in place). The device must then be recommissioned with the ETS.

During secure operation: A master reset deactivates device security. The device can then be recommissioned with the device certificate.

Performing a master reset

Precondition: The safe-state mode is activated.

- Press and hold down the programming button for > 5 s.
The programming LED flashes quickly.

The device performs a master reset, restarts and is ready for operation again after approx. 5 s.

Restoring the device to factory settings

Devices can be reset to factory settings with the Gira ETS Service App. This function uses the firmware contained in the device that was active at the time of delivery (delivery state). Restoring the factory settings causes the devices to lose their physical address and configuration.

5 Application programs

| | |
|------------------------|---|
| ETS search paths | Output / Binary output, 1fold / |
| Name | Switching, Inputs 20DF22 |
| Version: | 2.2 for ETS5 from Version 5.7.3 onwards and ETS6 |
| Mask version | SystemB (07B0) |
| Summarized description | Multifunctional switching application with inputs and logic functions. KNX Data Secure capable. |

6 Scope of functions

General

- KNX Data Secure capable.
- Three inputs for connecting potential-free switches, push-buttons or contacts (e.g. magnetic contacts). Signal evaluation of dew and leakage sensors at inputs 1...3 and acquisition of temperature values via NTC temperature sensor at input 3 (accessory) possible.
- If necessary, internal effect of inputs 1 and 2 in the application for switches, push-buttons or contacts on the relay output. With internal action, inputs 1 and 2 directly operate the switching output in a defined configuration. In the delivery state, operation of the switching output is possible via input 1 (switch).
- Up to 8 independent logic functions for the implementation of simple or complex logic operations.
- Actively transmitting feedback or status messages can be delayed globally after bus voltage return or after ETS programming.
- Updateable with Gira ETS Service App

Switching output

- Independent switching of the switching output.
- Operation as NO or NC contacts.
- Central switching of up to 6 switching objects (ON, OFF, permanent ON, permanent OFF).
- Switching feedback mode: Active (transmitting after changes or cyclically to the bus) or passive (object readout) feedback function.
- Reaction in case of bus voltage failure and bus voltage return as well as after ETS programming is adjustable.
- Logic operation function.
- Disabling function can be parameterized. Alternative forced position function.
- Timing functions (switch-on delay, switch-off delay, staircase lighting timer, also with pre-warning function)
- Incorporation into light moods: up to 64 internal scenes parameterizable.
- Operating hours counter can be activated.
- Input monitoring for cyclical updating of the switching object with safety position.

Inputs

- Depending on the ETS parameterisation in the application for switches, push-buttons or contacts, the inputs 1 and 2 either act internally on the relay output or alternatively also separately on the KNX. Input 3 always acts on the KNX if required.

- Individually adjustable functions for the inputs with effect on the KNX (switching, dimming, venetian blind, value transmitter, scene extension, 2-channel operation, controller extension, no function).
- Switching: Command adjustable when closing and opening the contact (no reaction, ON, OFF, TOGGLE). Presetting of the behaviour after bus voltage return possible.
- Dimming: Dimming of brightness and / or colour temperature. Command when closing the contact, time between switching and dimming, dimming in different steps, telegram repetition in case of long signal at the input and sending of a stop telegram at the end of the dimming process can be configured. Presetting of the behaviour after bus voltage return possible.
- Venetian blind: Command when closing the contact and operating concept parameterisable. Times for short and long signal at input and slat adjustment adjustable. Presetting of the behaviour after bus voltage return possible.
- Value transmitter: Functionality as 1 byte, 2 byte, 3 byte or 6 byte value transmitter incl. colour temperature and colour value transmitter possible. Individually configurable values. Optionally, a value adjustment is possible with a long signal at the input (not with the 6-byte value transmitter) and the specification of the behaviour after bus voltage recovery.
- Scene extension: The operating mode (with or without storage function) and the scene number is adjustable.
- 2-channel operation: When closing the contact at the input, up to two telegrams can be sent out on the KNX. Operating concept adjustable (channel 1 only or channel 2 / both channels). The functioning of the channels (1-bit, 1-byte, 2-byte, 3-byte, 6-byte) can be configured separately.
- Controller extension: The function (operating mode selection, forced operating mode switch-over, presence function and setpoint shift) is adjustable.
- Disabling of all or individual inputs possible via a 1-bit object. Polarity of the disabling object, behaviour at the beginning and end of disabling and behaviour during an active disabling can be set.

Logic functions

- The device has 8 internal logic functions in addition to the switching operation and the inputs.
- Logic gates (e.g. AND, OR, exclusive AND, exclusive OR, each with up to 4 inputs).
- 1-bit to 1-byte converter with input filter, disabling object and presetting of the output values.
- Disabling element with filter and time functions and disabling object.
- Comparator for values with 9 different input data formats and many comparison operations.
- Limit switch with hysteresis with upper and lower threshold for 9 different input data formats. Incl. presetting of the 1-bit output values.

- The logic functions have their own KNX communication objects and can process telegrams of the actuator or of other bus devices.

7 Notes on software

Unloading the application program

The application program can be unloaded with the ETS. In this case, the device has no function on the part of KNX. However, internal control of the relay output via input 1 is then possible.

ETS project design and commissioning

For project design and commissioning of the device, ETS5 from Version 5.7.3 onwards or ETS6 is required. Project designing and commissioning of the device using ETS2, ETS3 or ET4 is not possible.

8 Relay output

8.1 Priorities

The actuator in switching operation distinguishes between different functions that can have an effect on an output. In order to prevent conflicting output states, each available function has a certain priority. The function with the higher priority overrides the function with the lower priority.

For switching operation there are the following priorities...

- 1st priority: Forced position & disabling function,
- 2th priority: Cyclical monitoring,
- 3th priority: Logical operation function & Staircase function,
- 4th priority: direct bus operation ("switching" object, scenes, central functions, reset behaviour)

The behaviour of some functions can be configured at the end (e.g. the behaviour at the end of the disabling function). These predefined reactions are only executed if the actuator can then immediately switch to direct operation (lowest priority).

If another function with a lower priority has been activated during a function with a high priority, the actuator executes the behaviour at the beginning of the function with the next lower priority. The behaviour at the end of the function with the higher priority is then not executed!

8.2 General settings

8.2.1 Reset behaviour

Delay after bus voltage return

To reduce telegram traffic on the KNX bus line after bus voltage activation (bus reset), after connection of the device to the bus line or after an ETS programming operation, it is possible to delay all actively transmitted status or feedback telegrams of the switching function. For this purpose, a channel-independent delay can be specified (parameter "Delay after bus voltage return" on the parameter page "General -> General switching output"). Only after the configured time elapses are feedback telegrams for initialisation transmitted to the KNX.

Which of the telegrams is actually delayed and which is not can be specified for each status function separately.

- i** The delay has no effect on the behaviour of the output. Only the bus telegrams for status or feedback are delayed. The output can also be controlled during the delay after bus voltage return.
- i** A setting of "0" for the delay after bus voltage return deactivates the delaying function altogether. In this case, any messages, if actively transmitted, will be transmitted to the KNX without any delay.

8.2.1.1 Reset behaviour parameters

General -> General switching output

| | |
|--|-------------|
| Delay after bus voltage return Minutes (0...59) | 0...59 |
| <p>To reduce telegram traffic on the KNX bus line after bus voltage activation (bus reset), after connection of the device to the KNX line or after an ETS programming operation, it is possible to delay all actively transmitted status or feedback telegrams of the switching function. For this purpose, a delay time can be defined here. Only after the configured time elapses are feedback telegrams for initialisation transmitted to the KNX.</p> <p>Setting the delay time minutes.</p> | |
| Seconds (0...59) | 0...17...59 |
| <p>Setting the delay time seconds.</p> | |

8.2.2 Central functions

The actuator offers the possibility of linking the switching output with up to 6 1-bit communication objects. The behaviour during the control of the output via the central functions can be set to "Switching" or alternatively to "Permanent" (Switching with priority).

Central function = "Switching"

This function is comparable to various central group addresses that are linked to the "Switching" object of a switching output. The last command received (ON or OFF) is executed. The polarity of the central telegram can be configured as inverted if necessary.

Central function = "Permanent":

The switching output is controlled according to the parameterised command (ON or OFF) and locked during central control. This means that no other central function with the "Switching" function can control the locked output. Controls via normal switching objects are possible. If the output is assigned to several permanent central functions, the parameterised command decides on the priority of the central function. A "permanent OFF" has a higher priority than a "permanent ON" and thus is preferably executed. Activating a central function "permanent OFF" deactivates other assigned functions for the output with the setting "permanent ON".

Example of permanent central functions

The output is assigned to central function 1 "switching", central function 2 "permanent OFF" and central function 3 "permanent ON". Central functions 2 and 3 are initially deactivated.

When a central telegram = "activate" on central function 3 is received, the switching output switches on. In this state, it can no longer be controlled by central function 1, since a simple "switching" has a lower priority. When a central telegram = "activate" on central function 2 is received, the switching output switches off immediately.

Central function 3 is thus deactivated automatically. Only when central functions 2 and 3 are deactivated can the switching output be activated again by central function 1.

- i** After bus voltage return, all central functions are inactive. No central functions are saved in the event of a bus voltage failure.

Disconnect central functions

- Activate the central functions on the parameter page "General -> General switching output" with the parameter "Central functions".
The 6 central objects become visible in the ETS. Names can optionally be assigned for the central functions. The names should illustrate the use of the individual central functions (e.g. "All ON", "Central OFF"). The names are only used in the ETS in the text of the central functions and central objects.

Assign output to the central functions

The switching output can be assigned to the central functions.

The central functions must be enabled on the parameter page "General -> General switching output".

- The parameters "Function and polarity of the central object" on the parameter pages "Relay output ... -> SO... - General" to the desired function.

The output is assigned to the central function. It can be influenced centrally.

- i** The switching state newly set by the central functions is tracked in the feedback objects and also transmitted to the bus, if these are actively transmitting.

8.2.2.1 Central functions parameters

General -> General switching output

| | |
|--|---------------------|
| Central functions | Checkbox (yes / no) |
| If the parameter is activated, the 6 central functions of the switching output and thus the objects "Switching central function ..." are enabled. An assignment of the switching output to the central functions is only possible if the function is enabled. | |
| Name of the central functions | Free text |
| Names can optionally be assigned for the central functions. The names should illustrate the use of the individual central functions (e.g. "All ON", "Central OFF"). The names are only used in the ETS in the text of the central functions and central objects. | |

Relay output... -> SO... - General

| | |
|--|---|
| Central function X assignment (X = 1 ... 6) | Checkbox (yes / no) |
| These parameters assign the additional functions to the switching output. These parameters are only visible when central functions are enabled. | |
| Function and central object polarity | Switching (1 = ON / 0 = OFF) Switching (0 = ON / 1 = OFF) Permanent ON (1 = active / 0 = inactive) Permanent OFF (1 = active / 0 = inactive) |
| <p>The function and polarity of the central function is selected here.</p> <p>Switching (1 = ON / 0 = OFF): The last command received (ON or OFF) is executed. The polarity of the central telegram is preset: 1 = ON / 0 = OFF</p> <p>Switching (0 = ON / 1 = OFF): The last command received (ON or OFF) is executed. The polarity of the central telegram is preset: 0 = ON / 1 = OFF</p> <p>Permanent ON (1 = active / 0 = inactive): The switching output is switched on and locked during central control.</p> <p>Permanent OFF (1 = active / 0 = inactive): The switching output is switched off and locked during central control.</p> <p>If an output is assigned to several permanent central functions, the parameterised command decides on the priority of the central function. A "permanent OFF" has a higher priority than a "permanent ON" and thus is preferably executed. With permanent function, the polarity of the central telegram is always fixed: 1 = activate permanent control / 0 = deactivate permanent control.</p> <p>These parameters are only visible when central functions are enabled and assigned.</p> | |

8.2.2.2 Central functions objects

| Object no. | Function | Name | Type | DPT | Flag |
|------------|-----------|--------------------------------------|-------|-------|-----------------|
| 5 | Switching | Switching central function 1 - Input | 1-bit | 1,001 | C, (R), W, -, A |
| 6 | Switching | Switching central function 2 - Input | 1-bit | 1,001 | C, (R), W, -, A |
| 7 | Switching | Switching central function 3 - Input | 1-bit | 1,001 | C, (R), W, -, A |
| 8 | Switching | Switching central function 4 - Input | 1-bit | 1,001 | C, (R), W, -, A |
| 9 | Switching | Switching central function 5 - Input | 1-bit | 1,001 | C, (R), W, -, A |
| 10 | Switching | Switching central function 6 - Input | 1-bit | 1,001 | C, (R), W, -, A |

1-bit object for central control of the switching output.

With central function = "Switching": The polarity of the central telegram can be configured as inverted if necessary.

With central function = "Permanent ON", "Permanent OFF": With permanent function, the polarity of the central telegram is always fixed: 1 = activate permanent control / 0 = deactivate permanent control

8.2.3 Name of switching output

Here, you can optionally assign a name for the switching output. The name is intended to illustrate the use of the output (e.g. "light kitchen", "wall lamp living room"). The names are only used in the ETS in the text of the parameter pages and communication objects.

8.2.3.1 Parameter name

Relay outputs... -> SO... - General

| Name of switching output | Free text |
|--|-----------|
| The text entered in this parameter is applied to the name of the communication objects and is used to label the switching output in the ETS parameter window (e.g. "light kitchen", "wall lamp living room"). The text is not programmed in the device. | |

8.3 Operating mode

The relay of the switching output can be configured as NO or NC contacts. In this way, the inversion of switching states is possible.

The parameter "Operating mode" exists on the parameter page "Relay output... -> SO... - General".

- Set the operating mode to "NO contact".
The relay works as an NO contact. The logical switching state of the switching output is not forwarded to the relay in inverted form.
Switching state = OFF ("0") -> relay contact open,
Switching state = ON ("1") -> relay contact closed.
- Set the operating mode to "NC contact".
The relay works as an NC contact. The logical switching state of the switching output is forwarded to the relay in inverted form.
Switching state = OFF ("0") -> relay contact closed,
Switching state = ON ("1") -> relay contact open.
- i** The logic switching state "ON" or "OFF" is set by the communication object "Switching" and influenced by the functions that can be optionally activated (e.g. timing/staircase functions, logic operations, disabling/forced-control position functions, scenes, central objects).
- i** The 1-bit feedback always feed back the logical switching state of the switching output. Depending on the configured relay operating mode and an inverted or non-inverted evaluation, a status feedback has the following meanings:
NO contact not inverted: Feedback = "ON" -> Relay closed, feedback = "OFF" -> Relay opened
NO contact inverted: Feedback = "ON" -> Relay opened, feedback = "OFF" -> Relay closed
NC contact not inverted: Feedback = "ON" -> Relay opened, feedback = "OFF" -> Relay closed
NC contact inverted: Feedback = "ON" -> Relay closed, feedback = "OFF" -> Relay opened
- i** Feedback of the current switching status via the "switching" object is not possible.

8.3.1 Operating mode parameters

Relay output... -> SO... - General

| | |
|--|--------------------------|
| Operating mode | NO contact NC contact |
| <p>The relay of a switching output can be configured as NO or NC contacts. In this way, the inversion of switching states is possible.</p> <p>NO contact: Switching state = OFF ("0") -> Relay contact opened Switching state = ON ("1") -> Relay contact closed</p> <p>NC contact: Switching state = OFF ("0") -> Relay contact closed Switching state = ON ("1") -> Relay contact opened</p> | |

8.3.2 Operating mode objects

| Object no. | Function | Name | Type | DPT | Flag |
|---|-----------|----------------------|-------|-------|-----------------|
| 19 | Switching | Switching... - Input | 1-bit | 1,001 | C, (R), W, -, A |
| <p>1-bit input object to activate the switching output ("1" = Switch on / "0" = Switch off; "NO contact" or "NC contact" operating mode can be configured).</p> | | | | | |

8.4 Reset and initialisation behaviour

The switching states of the switching output in the event of a bus voltage failure, after bus voltage return or an ETS programming operation can be set separately.

Presetting the behaviour after ETS programming

The parameter "After ETS programming operation" exists for the switching output on the parameter page "Relay output... -> SO... - General". This parameter can be used to configure the switching state of the switching output, irrespective of the behaviour after bus voltage return.

- Set the parameter to "no reaction".
After ETS programming, the relay of the output shows no response and remains in the switching state last selected. The internal logical switching state is not lost by the ETS programming operation.
 - Set the parameter to "Open contact".
The relay contact opens after an ETS programming operation
 - Set the parameter to "Close contact".
The relay contact closes after an ETS programming operation
 - Set the parameter to "as with bus voltage return".
After an ETS programming operation, the switching output will behave in the manner defined in the parameter "After bus voltage return". If the behaviour there is configured to "state as before bus voltage failure", then that switching state is also set after an ETS programming operation which was active at the time of the last bus voltage failure. An ETS programming operation does not overwrite the saved switching state.
- i** The configured behaviour will be executed after every application or parameter download by the ETS. A simple download of the physical address alone or partial programming of only the group addresses has the effect that this parameter is disregarded and that the configured "After after bus voltage return" will be executed instead.
- i** A switching state set after an ETS programming operation is added to the feedback object. Actively transmitting feedback objects also only first transmit after an ETS programming cycle when the initialisation has finished and, if necessary, the "delay after bus voltage return" has elapsed.
- i** After an ETS programming operation, the disabling functions and the forced-positions are always deactivated. The states of the forced position objects saved in case of the bus voltage failure are deleted.

Setting the behaviour in case of bus voltage failure

The parameter "In case of bus voltage failure" is separately for the switching output on the parameter page "Relay output.... -> SO... - General".

- Set the parameter to "no reaction".

In case of bus voltage failure, the relay of the output shows no reaction and remains in the switching state last selected.

- Set the parameter to "Open contact".
The relay contact opens in case of bus voltage failure.
- Set the parameter to "Close contact".
The relay contact closes in case of bus voltage failure.
- i** Active disabling functions or forced position functions are cancelled and remain inactive until they are reactivated after a bus voltage return.
- i** In the event of bus voltage failure, the current status of the forced position is also saved so that it can be readjusted when the bus voltage returns (depending on the parameterisation of the forced position functions).
- i** In the event of bus voltage failure, the current switching state is stored internally so that this state can be restored after bus voltage recovery, if this is parameterised in the ETS.

Setting the behaviour after bus voltage return

The parameter "After bus voltage return" exists for the switching output on the parameter page "Relay output.... -> SO... - General".

- Set the parameter to "no reaction".
After bus voltage return, the relay of the output shows no reaction and remains in the switching state last selected.
- Set the parameter to "Open contact".
The relay contact is opened.
- Set the parameter to "Close contact".
The relay contact is closed.
- Set the parameter to "state as before bus voltage failure".
After bus voltage return, the switching state last set and internally stored before bus failure will be tracked.
- Preset parameter to "Activate staircase function". This setting is only available when the staircase function of the appropriate switching output is enabled.
The staircase function is – irrespective of the "Switching" object - activated after bus voltage return.
- i** Setting "state as before bus voltage failure": An ETS programming operation of the application or the parameter resets the stored switching state to "OFF".
- i** A switching state set after bus voltage return is tracked in the feedback objects. Actively transmitting feedback objects first transmit, however, after bus voltage return, when the initialisation of the actuator has finished, and if necessary the "Delay after bus voltage return" has elapsed.

- i** In the case of forced position as supplementary function: The communication object of the forced position can be initialised separately after bus voltage return. This has an effect on the reaction of the switching output when the forced position is activated on bus voltage return. The configured "Behaviour after bus voltage return" is only executed when no forced position after a bus voltage return is activated!
- i** In the case of enabling function as supplementary function: Active disabling functions are always inactive after bus voltage return.

8.4.1 Reset and initialisation behaviour parameter

Relay output... -> SO... - General

| | |
|--|---|
| After ETS programming operation | close contact open contact no reaction as with bus voltage return |
| <p>The actuator permits setting of the reaction for the switching output after an ETS programming operation.</p> <p>Close contact: The relay contact closes after an ETS programming operation</p> <p>Open contact: The relay contact opens after an ETS programming operation</p> <p>no reaction: After ETS programming, the relay of the output shows no response and remains in the switching state last selected. The internal logical switching state is not lost by the ETS programming operation.</p> <p>as with bus voltage return: After an ETS programming operation, the switching output will behave in the manner defined in the parameter "After bus voltage return". If the behaviour there is configured to "state as before bus voltage failure", then that switching state is also set after an ETS programming operation which was active at the time of the last bus voltage failure. An ETS programming operation does not overwrite the saved switching state.</p> | |
| In case of bus voltage failure | close contact open contact no reaction |
| <p>The actuator permits setting of the reaction for the switching output if there is a bus voltage failure.</p> <p>Close contact: The relay contact closes in case of bus voltage failure.</p> <p>Open contact: The relay contact opens in case of bus voltage failure.</p> <p>no reaction: In case of bus voltage failure, the relay of the output shows no reaction and remains in the switching state last selected.</p> | |

| | |
|--|---|
| After bus voltage return | close contact open contact state as before bus voltage failure no reaction activating staircase function |
| <p>The actuator allows the reaction to be set for the switching output after bus voltage return.</p> <p>Close contact: The relay contact is closed.</p> <p>Open contact: The relay contact is opened.</p> <p>State as before bus voltage failure: After bus voltage return, the switching state last set and internally stored before bus failure will be tracked.</p> <p>no reaction: After bus voltage return, the relay of the output shows no reaction and remains in the switching state last selected.</p> <p>Activate staircase function: The staircase function is – irrespective of the "Switching" object - activated after bus voltage return. This setting is only available when the staircase function is enabled.</p> | |

8.5 Cyclical monitoring

The actuator offers the option of monitoring the switching output cyclically for the arrival of switching telegrams. In this way, the objects which must be updated cyclically by the KNX can be monitored. In so doing, the polarity of the telegram update ("OFF" or "ON") is insignificant.

If there is no update of the monitored objects within a specifically configured monitoring time, then the switching output set itself to the preferred predefined contact position. However, this does not disable the output, so that, after the reception of a further switching telegram, the new switching state is set at the output.

The monitoring time can be defined for the switching output on the parameter page "Relay output... -> SO... - General" by the parameter "cycle time". The time is restarted for the switching output after each reception of a switching telegram via the objects "Switching" or "Central switching" (if at least one central function is assigned to the affected switching output). The monitoring time is also restarted automatically after bus voltage return or after an ETS programming operation.

Activate cyclical monitoring

The cyclical monitoring function can be activated for the switching output by the parameter "Cyclical monitoring" on the parameter page "Relay output... -> SO... - General". If the function is activated, as soon as the monitoring time elapses without having received a telegram update, the actuator sets the preference period for the switching output after the time has elapsed.

- Set the parameter to "no".
Cyclical monitoring is deactivated.
 - Set the parameter to "Yes, 'ON' when time has elapsed".
Cyclical monitoring is activated. After the time has elapsed, the switching output is switched on. The cycle time can be configured.
 - Set the parameter to "Yes, 'OFF' when time has elapsed".
Cyclical monitoring is activated. After the time has elapsed, the switching output is switched off. The cycle time can be configured.
- i** If cyclical monitoring is activated, the following functions cannot be configured: Time delays, staircase function, logic operation and scene.
- i** The disabling and forced position function has a higher priority than the cyclical monitoring.

8.5.1 Cyclical monitoring parameters

Relay output... -> SO... - General

| | |
|---|---|
| Cyclical monitoring | no yes, "ON" when time has elapsed yes, "OFF" when time has elapsed |
| <p>The actuator offers the option of monitoring the switching output cyclically for the arrival of switching telegrams. In this way, the objects which must be updated cyclically by the KNX can be monitored. In so doing, the polarity of the telegram update ("OFF" or "ON") is insignificant. If there is no update of the monitored objects within a specifically configured monitoring time, then the switching output set itself to the preferred predefined contact position. However, this does not disable the output, so that, after the reception of a further switching telegram, the new switching state is set at the output.</p> <p>no: Cyclical monitoring is deactivated.</p> <p>yes, 'ON' when time has elapsed: Cyclical monitoring is activated.. After the time has elapsed, the switching output is switched on.</p> <p>yes, 'OFF' when time has elapsed: Cyclical monitoring is activated.. After the time has elapsed, the switching output is switched off.</p> | |
| Cycle time hours (0...23) | 0...23 |
| <p>The monitoring time for cyclical monitoring is set here. Sets the monitoring time hours. This parameter is only visible if cyclical monitoring is enabled.</p> | |
| Minutes (0...59) | 0...2...59 |
| <p>Sets the monitoring time minutes. This parameter is only visible if cyclical monitoring is enabled.</p> | |
| Seconds (0...59) | 0...59 |
| <p>Sets the monitoring time seconds. This parameter is only visible if cyclical monitoring is enabled.</p> | |

8.6 Feedback switching status

The actuator can track the current switching state of the switching output via a feedback object and can also transmit them to the KNX. On each switching operation, the actuator determines the object value of the feedback. The actuator tracks the switching state and updates the feedback object even when a switching output, for example, is activated by a supplementary function or scene function.

The switching status feedback object is updated after the following events...

- Immediately after switch-on of a switching output (if necessary, first after a switch-on delay has elapsed / also after a staircase function).
- After switch-off of a switching output (if necessary, only after a switch-off delay has elapsed / also after a staircase function).
- During updating of the switching state from "ON" to "ON" or "OFF" to "OFF" when the switching output is already switched on or off. However, only if the parameter "Update of the object value" is configured to "On each update of object 'Switching'/'Central'".
- At the start or end of a disabling or forced position function, if a state changes as a result.
- Always on bus voltage return or at the end of any ETS programming process (if necessary, also delayed).

i In the case of enabling function as supplementary function: A "flashing" switching channel is always reported as "switched on".

Activate switching status feedback

The switching status feedback can be used as an active message object or as a passive status object. As an active message object, the switching status feedback information is also directly transmitted to the KNX whenever the feedback value is updated. As a passive status object, there is no telegram transmission after an update. In this case, the object value must be read out. The ETS automatically sets the object communication flags required for proper functioning.

Optionally, the actuator can also feed back the status of an independent switching output in inverted form.

The parameter "switching status" exists for the switching output on the parameter page "Relay output... -> SO... - General -> Feedback telegrams". Feedback takes place via the "Switching feedback" object.

Precondition:

The feedbacks must be enabled on the parameter page "Relay output... -> SO... - General -> Enabled" functions.

- Set the parameter to "no inversion, active signalling object".
A switching status is transmitted as soon as it is updated. An automatic telegram transmission of the feedback takes place after bus voltage return or after programming with the ETS. The switching status is written to the object in non-inverted form.
- Set the parameter to "no inversion, active signalling object".

A switching status will be transmitted in response only if the feedback object is read out from by the KNX. No automatic telegram transmission of the feedback takes place after bus voltage return or after programming with the ETS. The switching status is written to the object in non-inverted form.

- Set the parameter to "Invert, active signalling object".

A switching status is transmitted as soon as it is updated. An automatic telegram transmission of the feedback takes place after bus voltage return or after programming with the ETS. The switching status is written to the object in inverted form.

- Set the parameter to "Invert, passive status object".

A switching status will be transmitted in response only if the feedback object is read out from by the KNX. No automatic telegram transmission of the feedback takes place after bus voltage return or after programming with the ETS. The switching status is written to the object in inverted form.

- Set the parameter to "no reaction".

The switching status feedback of the affected switching output is deactivated.

- i** Depending on the configured relay operating mode and an inverted or non-inverted evaluation, a status feedback has the following meanings:
- NO contact not inverted: Feedback = "ON" -> Relay closed, feedback = "OFF" -> Relay opened
- NO contact inverted: Feedback = "ON" -> Relay opened, feedback = "OFF" -> Relay closed
- NC contact not inverted: Feedback = "ON" -> Relay opened, feedback = "OFF" -> Relay closed
- NC contact inverted: Feedback = "ON" -> Relay closed, feedback = "OFF" -> Relay opened

- i** Feedback of the current switching status via the "switching" object is not possible.

Set update of "Switching feedback"

In the ETS, you can specify when the actuator should update the feedback value for the switching status (object "Switching feedback") in case of an actively transmitting communication object. The object value updated by the actuator is then signalled actively to the KNX.

The parameter "Update of the object value" can be preset for the switching output on the parameter page "Relay output... -> SO... - General -> Feedback telegrams".

Precondition:

The feedbacks must be enabled on the parameter page "Relay output... -> SO... - General -> Enabled" functions. In addition, the switching status feedback must be configured to actively transmitting.

- Set the parameter to "after each update object 'Switching'/'Central'".

The actuator updates the feedback value in the object once a new telegram is received on the input objects "Switching" or "Central switching" or the switching state changes internally (e.g. through a time function). With an actively transmitting feedback object, a new telegram is also then actively transmitted to the KNX each time. The telegram value of the feedback does not necessarily have to change in the process. Hence, a corresponding switching status feedback is also generated on the "Switching" object such as in the case of cyclical telegrams for example.

- Set the parameter to "Only if the feedback value changes".

The actuator only updates the feedback value in the object if the telegram value (e.g. "OFF" to "ON") also changes or the switching state changes internally (e.g. through a time function). If the telegram value of the feedback does not change (e.g. in the case of cyclical telegrams to the "Switching" object with the same telegram value), the actuator does not transmit any feedback. Consequently, with an actively transmitting feedback object, no telegram with the same content will be transmitted repeatedly either.

This setting is recommendable, for instance, if the "Switching" and "Switching feedback" objects are linked to an identical group address. This is often the case when activating by means of light scene push-button sensors (recall and storage function).

Setting switching status feedback on bus voltage return or after programming with the ETS

If used as active message object, the switching status feedback information is transmitted to the KNX after bus voltage return or after programming with the ETS. In these cases, the feedback can be time-delayed.

- Activate the parameter "Delay after bus voltage return" on the parameter page "Relay output... -> SO... - General ->Feedback telegrams".

The switching status telegram is transmitted with a delay after bus voltage return or after an ETS programming operation. No feedback telegram is transmitted during a running delay, even if the switching state changes during this delay.

- Deactivate the parameter.

The switching status telegram is transmitted immediately after bus voltage return or after an ETS programming operation.

Setting cyclical transmission of the switching status feedback telegram

The switching status feedback telegrams can, if active, also be transmitted cyclically, in addition to the transmission after updating.

- Activate the parameter "cyclical transmission" on the parameter page "Relay output... -> SO... - General ->Feedback telegrams".

Cyclical transmission is activated. The cycle time for the switching status feedback can be configured separately for the parameter "Time for cyclical transmission".

- Deactivate the parameter.

Cyclical transmission is deactivated so that the feedback is transmitted to the KNX only when updated by the actuator.

8.6.1 Feedback switching status parameters

Relay output... -> SO... - General -> Enabled functions

| | |
|--|---------------------|
| Feedback telegrams | Checkbox (yes / no) |
| This parameter can be used to disable or to enable the feedback functions. | |

Relay output... -> SO... - General -> Feedback telegrams

| | |
|--|--|
| switching status | no feedback no inversion, active signalling object no inversion, passive status object inversion, active signalling object inversion, passive status object |
| <p>The current switching state of the switching output can be reported separately back to the KNX.</p> <p>no feedback: The switching status feedback of the affected switching channel is deactivated.</p> <p>no inversion, active signalling object: A switching status is transmitted as soon as it is updated. An automatic telegram transmission of the feedback takes place after bus voltage return or after programming with the ETS. The switching status is written to the object in non-inverted form.</p> <p>no inversion, passive status object: A switching status will be transmitted in response only if the feedback object is read out from by the KNX. No automatic telegram transmission of the feedback takes place after bus voltage return or after programming with the ETS. The switching status is written to the object in non-inverted form.</p> <p>inversion, active signalling object: A switching status is transmitted as soon as it is updated. An automatic telegram transmission of the feedback takes place after bus voltage return or after programming with the ETS. The switching status is written to the object in inverted form.</p> <p>inversion, passive status object: A switching status will be transmitted in response only if the feedback object is read out from by the bus. No automatic telegram transmission of the feedback takes place after bus voltage return or after programming with the ETS. The switching status is written to the object in inverted form.</p> | |

| | |
|--|---|
| Updating of the object value | after each update object "Switching"/"Central" only if the feedback value changes |
| <p>Here, you can specify when the actuator should update the feedback value for the switching status (object "Switching feedback") in case of an actively transmitting communication object. The object value updated by the actuator is then signalled actively to the KNX.</p> <p>This parameter is only visible in case of an actively transmitting feedback.</p> <p>after each update object "Switching"/"Central": The actuator updates the feedback value in the object once a new telegram is received on the input objects "Switching" or "Central switching" or the switching state changes internally (e.g. through a time function). With an actively transmitting feedback object, a new telegram is also then actively transmitted to the KNX each time. The telegram value of the feedback does not necessarily have to change in the process. Hence, a corresponding switching status feedback is also generated on the "Switching" object such as in the case of cyclical telegrams for example.</p> <p>only if the feedback value changes: The actuator only updates the feedback value in the object if the telegram value (e.g. "OFF" to "ON") also changes or the switching state changes internally (e.g. through a time function). If the telegram value of the feedback does not change (e.g. in the case of cyclical telegrams to the "Switching" object with the same telegram value), the actuator does not transmit any feedback. Consequently, with an actively transmitting feedback object, no telegram with the same content will be transmitted repeatedly either.</p> | |
| Delay after bus voltage return | Checkbox (yes / no) |
| <p>The states of the switching status feedback can be transmitted to the KNX with a delay after bus voltage return or after an ETS programming operation. The activated parameter causes a delay on bus voltage return. The delay time is configured on the parameter page "General -> General switching output".</p> <p>This parameter is only visible in case of an actively transmitting feedback.</p> | |
| Cyclical transmission | Checkbox (yes / no) |
| <p>The switching status feedback telegrams can, if actively transmitting, also be transmitted cyclically, in addition to the transmission after updating.</p> <p>This parameter is only visible in case of an actively transmitting feedback.</p> <p>Parameter activated: Cyclical transmission is activated.</p> <p>Parameter deactivated: Cyclical transmission is deactivated so that the feedback is transmitted to the KNX only when updated by the actuator.</p> | |
| Time for cyclical transmission hours (0...23) | 0...23 |
| <p>This parameter defines the time for the cyclical transmission of the switching status feedback.</p> <p>Setting the cycle time hours. This parameter is only available if cyclical transmission is activated.</p> | |

| | |
|---|------------|
| Minutes (0...59) | 0...2...59 |
| Setting the cycle time minutes. This parameter is only available if cyclical transmission is activated. | |
| Seconds (0...59) | 0...59 |
| Setting the cycle time seconds. This parameter is only available if cyclical transmission is activated. | |

8.6.2 Feedback switching status objects

| Object no. | Function | Name | Type | DPT | Flag |
|--|--------------------|-----------------------|-------|-------|---------------|
| 20 | Switching feedback | Switching... - Output | 1-bit | 1,001 | C, R, -, T, A |
| <p>1-bit object for feedback signalling of a switching state of the switching output ("1" = on / "0" = off) to the bus.</p> <p>Depending on the configured relay operating mode, the feedback value should be interpreted differently:</p> <p>NO contact operating mode: Feedback = "0" -> Relay open, feedback = "1" -> Relay closed</p> <p>NC contact operating mode: Feedback = "0" -> Relay closed, feedback = "1" -> Relay opened</p> | | | | | |

8.7 Time delays

Up to two time functions can be preset for the switching output. The time functions affect the communication objects "Switching" or "Central switching" only (if at least one of the central functions is activated for the output) and delay the object value received depending on the telegram polarity.

- i** At the end of a disabling function or forced position function, the switching state received during the function or set before the function can be tracked. Residual times of time functions are also tracked if these had not yet fully elapsed at the time of the reactivation or forced control.
- i** The time delays do not influence the staircase function if this is enabled.
- i** A time delay still in progress will be fully aborted by a reset of the actuator (bus voltage failure or ETS programming).

Activating switch-on delay

The switch-on delay can be activated in the ETS for the switching output.

Precondition:

The time delays must be enabled on the parameter page "Relay output... -> SO... - General -> Enabled" functions.

- Set the parameter "Selection of time delay" to "Switch-on delay" or to "Switch-on delay and switch-off delay". Configure the desired switch-on delay.
The switch-on delay is enabled. After reception of an ON telegram via the "switching" or "central switching" object, the configurable time is started. Another ON-telegram triggers the time only when the parameter "Switch-on delay retriggerable" is activated. An OFF-telegram received during the ON-delay will end the delay and sets the switching status to "OFF".

Activating switch-off delay

The switch-off delay can be activated in the ETS for the switching output.

Precondition:

The time delays must be enabled on the parameter page "Relay output... -> SO... - General -> Enabled" functions.

- Set the parameter "Selection of time delay" to "Switch-off delay" or to "Switch-on delay and switch-off delay". Configure the desired switch-off delay.
The switch-off delay is enabled. After reception of an OFF telegram via the "switching" or "central switching" object, the configurable time is started. Another OFF-telegram triggers the time only when the parameter "switch-off delay retriggerable" is activated. An ON-telegram received during the OFF-delay will end the delay and sets the switching status to "ON".

8.7.1 Time delays parameters

Relay output... -> SO... - General -> Enabled functions

| | |
|--|---------------------|
| Time delays | Checkbox (yes / no) |
| This parameter can be used to disable or to enable the time delays. The parameter is deactivated if cyclical monitoring is enabled. | |

Relay output... -> SO... - General -> Time delays

| | |
|--|---|
| Selection of time delay | no time delay Switch-on delay Switch-off delay ON delay and OFF delay |
| The communication objects "Switching" or "Central switching" can be evaluated after a time delay. By this setting the desired function of the time delay is selected and the additional parameters of the delay enabled. | |

| | |
|---|--------|
| Switch-on delay minutes (0...59) | 0...59 |
| This parameter is used for setting the duration of the switch-on delay. Sets the switch-on delay minutes. | |

| | |
|-----------------------------------|-------------|
| Seconds (0...59) | 0...10...59 |
| Sets the switch-on delay seconds. | |

| | |
|---|---------------------|
| Switch-on delay retriggerable | Checkbox (yes / no) |
| A switch-on delay still in progress can be retriggered by another "ON" telegram (parameter activated). Alternatively, the retriggering time (parameter deactivated) can be suppressed. The parameters for the switch-on delay are only visible if switch-on delay or switch-on and switch-off delay are activated. | |

| | |
|---|--------|
| Switch-off delay minutes (0...59) | 0...59 |
| This parameter is used for setting the duration of the switch-off delay. Sets the switch-off delay minutes. | |

| | |
|------------------------------------|-------------|
| Seconds (0...59) | 0...10...59 |
| Sets the switch-off delay seconds. | |

| | |
|--|---------------------|
| Switch-off delay retriggerable | Checkbox (yes / no) |
| A switch-off delay still in progress can be retriggered (parameter activated) by another "OFF" telegram. Alternatively, the retriggering time (parameter deactivated) can be suppressed. The parameters for the switch-off delay are only visible if switch-on delay or switch-on and switch-off delay are activated. | |

8.8 Staircase function

The staircase function can be used for implementing time-controlled lighting of a staircase or for function-related applications. The staircase function must be enabled in the ETS on parameter page "Relay output... -> SO... - General -> Enabled functions", in order for the required communication objects and parameters to be visible.

The staircase function is activated via the communication object "Staircase function start / stop" and is independent of the "switching" object of a switching output. In this way, parallel operation of time and normal control is possible, whereby the command last received is always executed: A telegram to the "switching" object or a scene recall at the time of an active staircase function aborts the staircase time prematurely and presets the switching state according to the received object value (the time delays are also taken into account) or scene value. Likewise, the switching state of the "switching" object can be overridden by a staircase function.

Time-independent continuous light switching can also be implemented in combination with a disabling function because the disabling function has a higher priority and overrides the switching state of the staircase function.

The staircase function can also be extended by means of a supplementary function. At the same time, it is possible to activate a time extension. The "time extension" permits retriggering of an activated staircase via the object "Staircase function Start / Stop" n times. Alternatively, the "time preset via the bus" can be set. With this supplementary function, the configured staircase time can be multiplied by a factor received via the bus, thus it can be adapted dynamically.

Furthermore, an extension of the staircase function can be implemented by means of a separate switch-on delay and pre-warning function. The pre-warning should, according to DIN 18015-2, warn any person still on the staircase that the light will soon be switched off.

Specifying switch-on behaviour of the staircase function

An ON telegram to the "Staircase function start/stop" object activates the staircase time (T_{ON}), the duration of which is defined by the parameters "Staircase time". In addition, a switch-on delay (T_{Delay}) can be activated (see "presetting switch-on delay of the staircase function"). At the end of the staircase time, the output switches off or activates optionally the pre-warning time ($T_{Prewarn}$) of the pre-warning function (see "presetting pre-warning function of the staircase function"). Taking into account any possible switch-on delay and pre-warning function, this gives rise to the switch-on behaviour of the staircase function as shown in the following diagram.

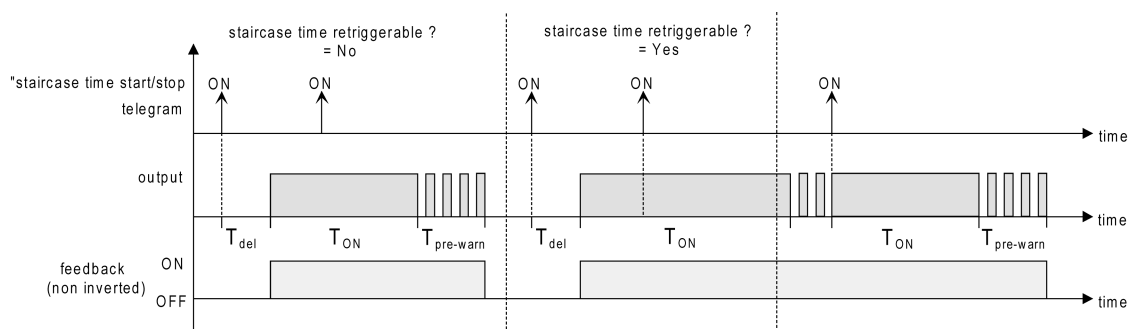

Image 6: Switch-on behaviour of the staircase function

The parameter "Staircase time retriggerable" specifies whether the staircase time can be retriggered.

Precondition:

The staircase function must be enabled on parameter page "Relay output... -> SO... - General -> Enabled functions".

- Activate parameter "Staircase time retriggerable".
Every ON telegram received during the ON phase of the staircase time retriggeres the staircase time completely.
 - Deactivate parameter "Staircase time retriggerable".
ON telegrams received during the ON phase of the staircase time are rejected. The staircase time is not retriggered.
- i** An ON telegram received during the pre-warning time always retriggeres the staircase time independently of the parameter "Staircase time retriggerable".
- i** When the supplementary function "Time extension" is preset, the parameter "Staircase time retriggerable" cannot be adjusted. In this case, it is permanently deactivated.

Specifying switch-off behaviour of the staircase function

In the case of a staircase function, the reaction to an OFF telegram can also be configured on the object "Staircase function start/stop". Without the receipt of an OFF telegram the output switches off after the pre-warning time elapses, if necessary. Taking into account any possible switch-on delay and pre-warning function, this gives rise to the switch-off behaviour of the staircase function as shown in the following diagram.

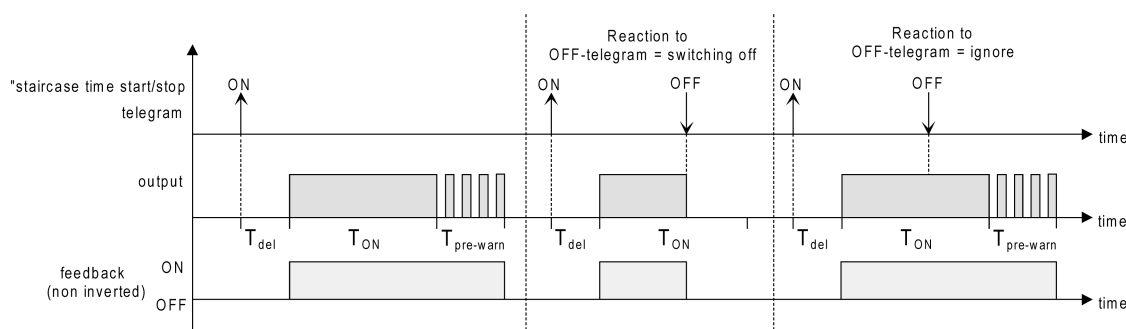

Image 7: Switch-off behaviour of the staircase function

The parameter "reaction to OFF-telegram" defines whether the staircase time (T_{ON}) of the staircase function can be aborted prematurely.

Precondition:

The staircase function must be enabled on parameter page "Relay output... -> SO... - General -> Enabled functions".

- Set parameter "Reaction to OFF-telegram" to "switch off".

As soon as an OFF telegram is received via the object "Staircase function start/stop" during the ON phase of the staircase time, the output switches off immediately. If the staircase time is stopped prematurely by such a telegram, there is no pre-warning, i.e. the pre-warning time is not started.

- Set parameter "Reaction to OFF-telegram" to ignore".
OFF telegrams received during the ON phase of the staircase time are rejected. The staircase time will be executed completely to the end with pre-warning if necessary.
- i** With the supplementary function "time preset via the bus", the staircase time of the staircase function can also be started by the reception of a new time factor. In this case, received "0" factors are interpreted as an OFF telegram. Here too, the parameter "Reaction to OFF telegram" is evaluated so that a staircase time can be cancelled early.
- i** The parameter "Reaction to OFF telegram" does not influence the reception and the evaluation of OFF telegrams via the "Switching" object.

Setting the switch-on delay of the staircase function

An ON telegram for activation of the staircase function can also be evaluated with a time delay. This switch-on delay can be activated separately for the staircase function and has no influence on the configurable time delays for the object "switching".

Precondition:

The staircase function must be enabled on parameter page "Relay output... -> SO... - General -> Enabled functions".

- On the parameter page "Relay output... -> SO... - General -> Staircase function" deactivate the parameter "Switch-on delay".
The switch-on delay is deactivated. After reception of an ON telegram on the object "Staircase function start/stop", the staircase time is activated immediately and the output switched on.
- Activate the parameter "switch-on delay".
The switch-on delay for the staircase function is enabled. The desired switch-on delay time can be specified. After reception of an ON telegram on the object "Staircase function start/stop", the switch-on delay is started. Another ON-telegram triggers the time only when the parameter "Switch-on delay retriggerable" is activated. The staircase time is activated and the output is switched on only after the time delay has elapsed.
- i** An OFF telegram via the object "Staircase function start/stop" during the switch-on delay only terminates the delay if the parameter "Reaction to OFF-telegram" is set to "switch off". Otherwise, the OFF telegram is ignored.
- i** When the supplementary function "Time extension" is preset, the parameter "Switch-on delay retriggerable" cannot be adjusted. In this case, it is permanently deactivated.

Setting the pre-warning function of the staircase function

The pre-warning should, according to DIN 18015-2, warn persons still on the staircase that the light will soon be switched off. The lighting connected on the output is briefly switched off repeatedly as a pre-warning, before the output is switched off permanently. At the same time, the pre-warning time (T_{Prewarn}), the duration of the interruptions during the pre-warning ($T_{\text{Interrupt}}$) and the number of pre-warning interruptions are configurable (see figure 8). The pre-warning time is added to the staircase time (T_{ON}). The pre-warning time influences the value of the feedback object so that the value "OFF" (in the case of non-inverted transmission) is first tracked after the pre-warning time in the object has elapsed.

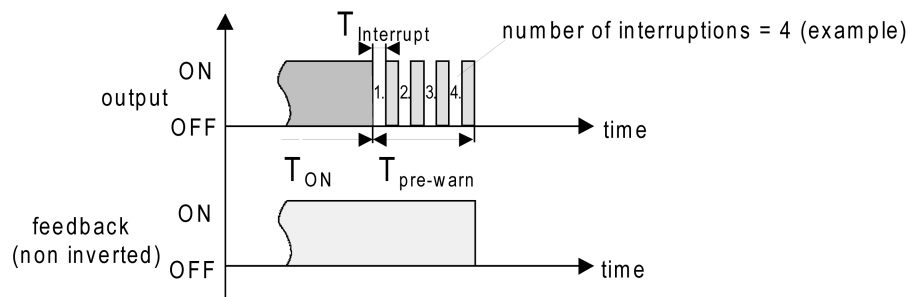

Image 8: The pre-warning function of the staircase function (example)

Precondition:

The staircase function must be enabled on parameter page "Relay output... -> SO... - General -> Enabled functions".

- On the parameter page "Relay output... -> SO... - General -> Staircase function" set the parameter "At the end of the staircase time" to "activate pre-warning time".

The pre-warning function is enabled. The desired pre-warning time (T_{Prewarn}) can be preset.
 - Set the parameter "Number of pre-warnings" to the desired value (1...10).

Within the pre-warning time, the lighting connected on the output is switched off just as often as configured here. The 1st pre-warning is always executed at the beginning of the entire pre-warning time.
 - Set the parameters "Time for pre-warning interruptions" to the desired value.

An interruption ($T_{\text{Interrupt}}$) during the pre-warning time is just as long as configured here. The adjustable interruption time allows the switch-off phase of the lighting to be adapted individually to the lamps used.
- i** It should be noted that the "number of pre-warnings" and the "time for pre-warning interruptions" must be attuned to the duration of the entire "pre-warning time". Hence, the entire switch-off phase during a pre-warning ("number of pre-warnings" + "time for pre-warning interruptions") must not be set longer than the pre-warning time! Otherwise, malfunctions can be expected.

- i** An ON telegram to the object "Staircase function start/stop" while a pre-warning function is still in progress stops the pre-warning time and always restarts the staircase time (independently of the parameter "Staircase time retriggerable"). Even during the pre-warning time, the parameter "reaction to OFF telegram" is evaluated so that a pre-warning in progress can be terminated early by switching off.

Setting supplementary function of the staircase function – time extension

With the time extension function, the staircase time can be retriggered several times (i.e. extended) via the "Staircase function start/stop" object. The duration of the extension is predefined by several operations at the control section (several ON telegrams in succession). The configured staircase time can be extended in this way by the configured factor (a maximum of 5-fold). The time is then always extended automatically at the end of a single staircase time (T_{ON}) (see figure 9).

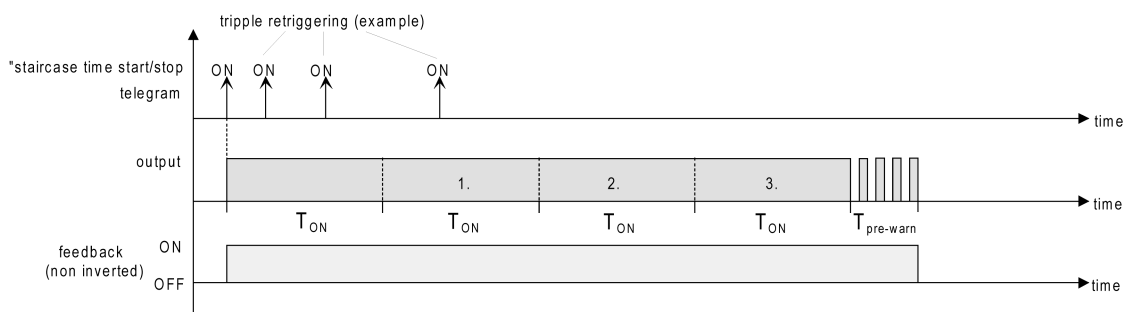

Image 9: Time extension of the staircase function

With this function, the lighting time in a staircase can be extended (e.g. by a person after shopping) by a defined length without having to retrigger the lighting every time the lighting shuts off automatically.

Precondition:

The staircase function must be enabled on parameter page "Relay output... -> SO... - General -> Enabled functions.

- On the parameter page "Relay output... -> SO... - General -> Staircase function" Set the parameter "Supplementary function for staircase function" to "time extension" and set the maximum desired factor on the parameter "maximum time extension".

The staircase time is retriggered each time an ON telegram is received on the "staircase time start/stop" object after the staircase time has elapsed, depending on the number of telegrams received, but only as often as pre-defined by the configured factor.

For example, the "3-fold time" setting means that after the started staircase time has elapsed, it can be retriggered automatically a maximum of three additional times. The time is therefore extended a maximum of four fold.

- i** A time extension can be triggered during the entire staircase time (T_{ON}). There is no time limit between two telegrams for the time extension. Telegrams for the time extension are only evaluated during the staircase time. An ON telegram during the pre-warning function triggers the staircase time as a restart,

which means that a new time extension is possible.

If a switch-on delay was configured, the time extension is recorded during the switch-on delay.

- i** If a time extension was configured as a supplementary function, the parameters "Staircase time retriggerable" and "Switch-on delay retriggerable" are permanently deactivated since the staircase time can be retriggered by the time extension.

Setting supplementary function of the staircase function – time preset via the bus

With time specification via the bus, the configured staircase time can be multiplied by an 8-bit factor received via the KNX, thus it can be adapted dynamically. With this setting, the factor is derived from the object "staircase time factor". The possible factor value for setting the staircase time is between 1...255.

The entire staircase time arises as a product from factor (object value) and the configured staircase time as a basis as follows...

Staircase time = (staircase time object value) x (staircase time parameter)

Example:

Object value "staircase time factor" = 5; parameter "staircase value" = 10s.

-> set staircase time = 5 x 10s = 50 s.

Alternatively, the staircase function parameter can define whether the receipt of a new factor also starts the staircase time of the staircase function at the same time. In this case, the object "Staircase function start/stop" is not necessary and the received factor value determines the starting and stopping.

Precondition:

The staircase function must be enabled on parameter page "Relay output... -> SO... - General -> Enabled functions.

- On the parameter page "Relay output... -> SO... - General -> staircase function" Set the parameter "supplementary function for staircase function" to "time preset via the bus" and deactivate the parameter "staircase function activatable via 'staircase time' object".

The staircase time can be adapted dynamically by the "staircase time factor" object. A value "0" is interpreted as value "1". The staircase function is started and stopped exclusively via the "staircase function start / stop" object.

- Activate the parameter "supplementary function" to "time preset via the bus" and activate the parameter "staircase function activatable via 'staircase time' object".

The staircase time can be adapted dynamically by the "staircase time factor" object. In addition, the staircase function is started with the new staircase time (the object "staircase function start / stop" is not necessary). A factor value "0" is interpreted as an OFF telegram, whereby in this case, the configured reac-

tion to an OFF telegram is evaluated, too.

A larger staircase with several floors is an example as an application for the time preset via the bus with automatic starting of the staircase time. On each floor there is a push-button sensor that transmits a factor value to the staircase function. The higher the floor, the greater the factor value transmitted so that the lighting stays switched on longer if the passing through the staircase needs more time. When a person enters a staircase and a pushbutton is pressed, the staircase time is now adjusted dynamically to the staircase time and switches on the lighting at the same time, too.

- i** The staircase function is started via the reception of a new factor: A factor > 0 received during a pre-warning time always triggers the staircase time independently of the parameter "Staircase time retriggerable".
- i** After a reset (bus voltage return or ETS programming) the "staircase time factor" object is always initialised with "1". However, the staircase function is not started automatically solely as the result of this (see "Set behaviour of staircase function after bus voltage return").
- i** The two supplementary functions "time extension" and "time preset via the bus" can only be configured alternatively.

Setting the behaviour of the staircase function after bus voltage return

The staircase function can optionally be started automatically after bus voltage return.

Precondition:

The staircase function must be enabled on parameter page "Relay output... -> SO... - General -> Enabled functions".

- On the parameter page "Relay output... -> SO... - General", set the parameter "After bus voltage return" to "Activate staircase function".
Immediately after bus voltage return, the staircase time of the staircase function is started.
- i** During automatic starting of the staircase function after bus voltage return, no switch-on delay is started if the staircase function has configured such a delay.
- i** The device only executes the configured "Behaviour on bus voltage return" only if the last ETS programming of the application or of the parameters ended at least approx. 20 s prior to switching on the bus voltage. Otherwise ($T_{ETS} < 20$ s) the behaviour "after ETS programming" will be adopted also in case of bus voltage return.
- i** The configured behaviour will only be executed, if no forced position on bus voltage return is activated.

8.8.1 Staircase function parameters

Relay output... -> SO... - General -> Enabled functions

| | |
|--|---------------------|
| Staircase function | Checkbox (yes / no) |
| This parameter can be used to disable or to enable the staircase function. The parameter is deactivated if cyclical monitoring is enabled. | |

Relay output... -> SO... - General -> Staircase function

| | |
|---|--------|
| Staircase time hours (0...23) | 0...23 |
| This parameter is used for programming the duration of the switch-on time for a scene recall. Switch-on time hours setting. | |

| | |
|---------------------------------|------------|
| Minutes (0...59) | 0...3...59 |
| Switch-on time minutes setting. | |

| | |
|---------------------------------|--------|
| Seconds (0...59) | 0...59 |
| Switch-on time seconds setting. | |

| | |
|--|---------------------|
| Staircase time retriggerable | Checkbox (yes / no) |
| An active switch-on time can be retriggered (parameter activated). Alternatively, the retriggering time (parameter deactivated) can be suppressed. This parameter is preset to deactivated if the supplementary function "Time extension" is configured. Re-triggering will not be possible. | |

| | |
|---|---------------------|
| Switch-on delay | Checkbox (yes / no) |
| The staircase function enables the activation of an own switch-on delay. This switch-on delay affects the trigger result of the staircase function and thus delays the switch-on. activated: The switch-on delay for the staircase function is enabled. After reception of an ON telegram on the object "Staircase function start/stop", the switch-on delay is started. Another ON-telegram triggers the time only when the parameter "Switch-on delay retriggerable" is activated. The staircase time is activated and the output is switched on only after the time delay has elapsed. deactivated: The switch-on delay is deactivated. After reception of an ON telegram on the object "Staircase function start/stop", the staircase time is activated immediately and the output switched on. | |

| | |
|---|--------|
| Switch-on delay hours (0...23) | 0...23 |
| This parameter is used for setting the duration of the switch-on delay. Sets the switch-on delay hours. | |

| | |
|-----------------------------------|--------|
| Minutes (0...59) | 0...59 |
| Sets the switch-on delay minutes. | |

| | |
|-----------------------------------|-------------|
| Seconds (0...59) | 0...30...59 |
| Sets the switch-on delay seconds. | |

| | |
|--|--|
| Switch-on delay retriggerable | Checkbox (yes / no) |
| <p>An active switch-on delay can be retriggered (parameter activated). Alternatively, the retriggering time (parameter deactivated) can be suppressed.</p> <p>This parameter is deactivated if the supplementary function "Time extension" is configured. Re-triggering will not be possible.</p> <p>The parameters for the switch-on delay are only visible when the switch-on delay is used.</p> | |
| Reaction to OFF-telegram | <p>switch off</p> <p>ignore</p> |
| <p>An active switch-on time can be aborted prematurely by switching off the staircase function.</p> <p>switch off: The switch-on time is aborted after receipt of an OFF telegram on the object "Staircase time start/stop".</p> <p>With the supplementary function "time preset via the bus" and the setting "Staircase function activatable via object 'Staircase time' = activated" the switch-on time can also be prematurely ended by a factor of "0".</p> <p>ignore: OFF Telegrams or "0" factors are ignored. The switch-on time will be executed completely to the end.</p> | |
| Supplementary function | <p>no supplementary function</p> <p>time extension</p> <p>time preset via the bus</p> |
| <p>The staircase function can be extended by the two supplementary functions "Time extension" and "Time specifications via bus", which should be used alternatively. This parameter enables the desired supplementary function and thereby activates the necessary parameters or objects.</p> <p>no supplementary function: No supplementary function is enabled.</p> <p>Time extension: The time extension is activated. This function permits retriggering an activated staircase lighting time span-times via the object "Staircase function start/stop".</p> <p>Time preset via the bus: The time preset via the bus is activated. With this supplementary function, the configured switch-on time can be multiplied by a factor received via the KNX, thus it can be adapted dynamically.</p> | |

| | |
|---|--|
| Maximum time extension | 1-fold staircase time 2-fold staircase time 3-fold staircase time 4-fold staircase time 5-fold staircase time |
| <p>In case of a time extension (retriggering the lighting time n-times via the object "Staircase function start/stop), the parameterized staircase lighting time will be extended by the value programmed in this parameter.</p> <p>"1-fold staircase time" means that after the started staircase time has elapsed, it can be retriggered a maximum of one more time. The time is therefore extended two fold. The other settings behave in a similar manner.</p> <p>This parameter is visible only if the supplementary function "time extension" is set.</p> | |
| Staircase function activatable via "Staircase time" object | Checkbox (yes / no) |
| <p>A time preset via the bus can specify here whether the receipt of a new time factor also starts the switch-on time (parameter activated). At the same time, the object "Staircase function start/stop" is hidden.</p> <p>If the parameter is deactivated, the switch-on time can be activated exclusively via the object "Staircase function start/stop".</p> <p>This parameter is visible only if the supplementary function "time preset via the bus" is set.</p> | |
| At the end of the staircase time | switch off activate pre-warning time |
| <p>At the end of the staircase time, the actuator for the switching output concerned displays the configured behaviour here. The output can be set to switch off immediately or alternatively to execute a pre-warning function.</p> <p>switch off: At the end of the staircase time, the actuator switches off the switching output concerned.</p> <p>Activate pre-warning time: At the end of the staircase time, the switching output can generate a pre-warning prior to switching off. The pre-warning, for example, should warn any person still on the staircase that the light will soon be switched off.</p> | |
| Pre-warning time minutes (0...59) | 0...59 |
| <p>This parameter is used for setting the duration of the pre-warning time. The pre-warning time is added to the switch-on time. Sets the pre-warning time in minutes.</p> | |
| Seconds (0...59) | 0... 30 ...59 |
| <p>Sets the pre-warning time in seconds.</p> <p>These parameters are visible only if the pre-warning function is enabled.</p> | |

| | |
|---|---------------|
| Time for early warning interruptions seconds (0...59) | 0...59 |
| This parameter defines the duration of a pre-warning interruption, i.e. how long the switching output is to remain off during a pre-warning interruption. The time should be customized individually to the switch-off behaviour of the lamp used. Sets the pre-warning interruption seconds. | |
| Milliseconds (0...900) | 0...500...900 |
| Sets the pre-warning interruption milliseconds (in 100-ms increments). | |
| Number of pre-warnings(1...10) | 1...3..10 |
| This parameter defines how often the switching output is to switch off within the pre-warning time. i.e. how many pre-warnings will be generated. | |

8.8.2 Staircase function objects

| Object no. | Function | Name | Type | DPT | Flag |
|---|-------------------------------|----------------------|---------|-------|-----------------|
| 29 | Staircase function start/stop | Switching... - Input | 1-bit | 1,010 | C, (R), W, -, A |
| 1-bit object to activate or deactivate the switch-on time of the staircase function of the switching output ("1" = switch-on / "0" = switch-off). | | | | | |
| Object no. | Function | Name | Type | DPT | Flag |
| 30 | Staircase time factor | Switching... - Input | 1 bytes | 5,010 | C, (R), W, -, A |
| 1-byte object to specify a time factor for the switch-on time of the staircase function (value range: 0... 255). | | | | | |

8.9 Scene function

Up to 64 scenes can be programmed and scene values stored for the switching output. The scene values are recalled or stored via a separate scene extension object. The data point type of the extension object permits addressing of all 64 scenes.

The scene function must be enabled on parameter page "Relay output... -> SO... - General -> Enabled functions" for the switching output, in order for the required communication objects and parameters (on the parameter page "Relay output... -> SO... - General -> Scenes") to become visible.

The scene configuration selected in the parameterization decides whether the number of scenes is either variable (1 ... 64) or alternatively fixed to the maximum (64).

- Scene configuration = "variable (1 ... 64 scenes)"
With this setting, the number of scenes used can be selected anywhere in the range 1 to 64. The parameter "Number of scenes" decides how many scenes are visible for the switching output in the ETS and can therefore be used. It is possible to specify which scene number (1 ... 64) controls each scene.
- Scene configuration = "fixed (64 scenes)"
With this setting, all scenes are always visible and can therefore be used. The scenes are controlled via permanently assigned scene numbers (1 ... 64) (scene number 1 -> scene 1, scene number 2 -> scene 2 ...). If necessary, individual scenes can be deactivated.

The scene function can be combined together with other functions of the switching output, whereby the last received or preset state is always executed: Telegrams to the "Switching" objects, a scene recall or scene storage telegram at the time of an active staircase function aborts the staircase time prematurely and presets the switching state according to the received object value (time delays are also taken into account) or scene value.

Similarly, the state of the switching output, which was preset by the "Switching", "Dimming" or "Brightness value" objects or by a scene recall, can be overridden by a staircase function.

Presetting a scene recall delay

Each scene recall of a switching output can optionally also be delayed. With this feature, dynamic scene sequences can be configured if several scene outputs are combined with cyclical scene telegrams.

Precondition

The scene function must be enabled on parameter page "Relay output... -> SO... - General -> Enabled functions".

- On the parameter page "Relay output... -> SO... - General -> Scenes" activate the parameter "Delay scene recall".

The delay time is now activated and can be configured separately. The delay only influences the scene recall of the switching output. The delay time is started on arrival of a recall telegram. The corresponding scene will be recalled and the switching channel set to the switching state value only after this time has elapsed.

- i** Each scene recall telegram restarts the delay time and retriggers it. If a new scene recall telegram is received while a delay is active (scene recall not yet executed), the old (and not yet recalled scene) will be rejected and only the scene last received executed.
- i** The scene recall delay has no influence on the storage of scene values. A scene storage telegram within a scene recall delay terminates the delay and thus the scene recall.

Presetting the behaviour during ETS programming

When a scene is saved, the switching states are saved permanently in the device. To prevent the stored values from being replaced during ETS programming of the application or parameters by the originally programmed scene switching states, the actuator can inhibit overwriting of the switching states. As an alternative, the original values can be reloaded into the device during each programming run of the ETS.

Precondition

The scene function must be enabled on parameter page "Relay output... -> SO... - General -> Enabled functions".

- On the parameter page "Relay output... -> SO... - General -> Scenes", activate the parameter "Overwrite values stored in the device during the ETS programming operation".

During each ETS programming operation of the application or of the parameters, the scene switching states configured in the ETS for the switching output concerned will be programmed into the actuator. Scene switching states stored in the device by means of a storage function will be overwritten, if any.

- Deactivate the parameter "Overwrite values stored in the device during the ETS programming operation".

Scene switching states stored in the device with a storage function will be maintained. If no scene switching states have been stored, the switching states last programmed in the ETS remain valid.

- i** When the actuator is commissioned for the first time, this parameter should be activated so that the switching output is initialised with valid scene switching states.

Setting scene numbers and scene switching states

The presetting of the scene number depends on the selected scene configuration. With variable configuration the scene number (1...64) with which the scene is addressed, i.e. recalled or stored, must be determined for each scene of the switching output. With a fixed scene configuration, the number of a scene is preset invariably. The data point type of the scene extension object permits addressing of up to 64 scenes max.

In addition to specifying the scene number, it is necessary to define which scene command (ON, OFF) should be set on the switching output during a scene recall.

Precondition

The scene function must be enabled on parameter page "Relay output... -> SO... - General -> Enabled functions".

- Only with variable scene configuration. On the parameter page "Relay output... -> SO... - General -> Scenes", set the parameter for each scene to the numbers with which the scenes are to be addressed.

A scene can be addressed with the configured scene number. A setting of "0" deactivates the corresponding scene so that neither recalling nor storage is possible.

- Only with fixed scene configuration. On the parameter page "Relay output... -> SO... - General -> Scenes" select or deselect the parameter "Scene active" if necessary.

Only selected scenes can be used. A deselected scene is deactivated and cannot be recalled or stored via the scene extension.

i If with variable scene configuration the same scene number is configured for several scenes, only the scene with the lowest sequential number will be addressed. The other scenes will be ignored in this case.

- On the parameter page "Relay output... -> SO... - General -> Scenes" set the parameter "Switching state for each scene to the desired switching command. During a scene recall, the configured switching state is recalled and set on the switching output.

i The configured switching state is adopted in the actuator during programming with the ETS only if the parameter "Overwrite values stored in the device during ETS download" is activated.

Presetting storage behaviour

The switching state set for the switching output can be stored internally via the extension object on reception of a scene storage telegram. In this case, the switching state can be influenced before the storage by all functions of the switching output provided that the individual functions have been enabled (e.g. also the disabling function, forced-control position function etc.).

Precondition

The scene function must be enabled on parameter page "Relay output... -> SO... - General -> Enabled functions".

- On the parameter page "Relay output... -> SO... - General -> Scenes" activate the parameter "storage function" for each scene.

The storage function is activated for the scene in question. On reception of a storage telegram via the "Scene extension" object, the current switching state will be internally stored.

- Deactivate the parameter "storage function" for each scene.

The storage function is deactivated for the scene in question. A storage telegram received via the "scene extension" object will be rejected.

Optionally, a visual feedback via the switching output can be signaled when executing a storage command. The channel flashes once as feedback in the configured flashing time. This enables the system operator to determine locally whether the desired scene switching state has been saved correctly in the actuator. A switching state feedback on the KNX is not generated.

- On the parameter page "Relay output... -> SO... - General -> Scenes" activate the parameter "visual feedback for storage function". In the parameter "Flashing time", set the time in which the visual feedback is to be executed.

When a storage function is executed, the visual feedback is activated immediately. The output switches to the opposite switching state for the duration of the configured flashing time and then back to the saved scene command.

- Deactivate the parameter "visual feedback for storage function".

When storing a scene, the visual feedback is not executed. The actuator adopts the current switching state of the output without special feedback.

- i** The visual feedback is only executed if no other function with a higher priority (e.g. disabling function) is active in the moment when the memory function is active.

Configure extended scene recall

The extended scene recall allows recalling of up to 64 scenes of the switching output in sequence. Here, scene recall takes place via the 1-bit communication object "Extended scene recall". Each ON telegram received via this object recalls the next of the available scenes in the configuration. Each OFF telegram received recalls the previous scene.

With the extended scene recall, the actuator always recalls the neighbouring scene - starting with the scene most recently recalled via the extended recall. It is irrelevant whether the scene is active on the appropriate switching output (scene number = "1...64" or scene active) or inactive (scene number = "0" or scene inactive). If an inactive scene is recalled via the extended scene recall, the appropriate switching output will not react.

Only the scenes available in the scene configuration can be selected via the extended scene recall (with "variable" defined by the parameter "number of scenes", with "fixed" always all 64 scenes). After a reset (bus voltage return, ETS programming operation), an ON or OFF telegram always recalls scene 1 first.

- i** Recall of a scene via the 1-byte extension object does not influence the scene sequence of the extended scene recall. The two recall functions work independently of each other.

- Activate the parameter "Extended scene recall" on the parameter page "Relay output... -> SO... - General -> Scenes".

The object "Extended scene recall" is available. Each ON telegram recalls the next scene. Each OFF telegram recalls the previous scene.

- Deactivate the parameter "Use extended scene recall".

The extended scene recall is deactivated. A scene recall can only take place via the 1-byte scene extension object.

The extended scene recall can take place with or without an overflow at the scene limits. An overflow occurs when the last scene of the selected configuration is reached when counting up or scene 1 when counting down and an additional telegram in the last counting direction is received by the actuator. The overflow behaviour is defined in the ETS.

- Activate the parameter "with overflow".

After reaching the last scene of the selected configuration, a further ON telegram of the overflow is executed and scene 1 is recalled. Similarly, after reaching scene 1, the overflow is executed by further OFF telegram and the last scene of the selected configuration is recalled.

- Deactivate the parameter "With overflow".

A scene overflow is not possible. After reaching the last scene of the selected configuration, further ON telegrams of the extended scene recall are ignored. In the same way, the actuator ignores further OFF telegrams if scene 1 was recalled last.

8.9.1 Scene function parameters

Relay output... -> SO... - General -> Enabled functions

| | |
|--|---------------------|
| Scene function | Checkbox (yes / no) |
| This parameter can be used disable or to enable the scene function. The parameter is deactivated if cyclical monitoring is enabled. | |

Relay output... -> SO... - General: -> Scenes

| | |
|---|---------------------|
| Delay scene recall | Checkbox (yes / no) |
| A scene is recalled via the scene extension object. If required, the scene recall can be delayed on reception of a recall telegram (parameter activated). The recall is alternatively made immediately on reception of the telegram (parameter deactivated) | |

| | |
|--|--------|
| Delay time minutes (0...59) | 0...59 |
| This parameter specifies the length of the scene delay time. Sets the scene delay time in minutes. | |

| | |
|--|-------------|
| Seconds (0...59) | 0...10...59 |
| Sets the scene delay time in seconds. The delay time parameters are only visible, if the parameter "Delay scene recall" is activated. | |

| | |
|---|---------------------|
| Visual feedback for storage function | Checkbox (yes / no) |
| Optionally, a visual feedback via the switching output can be signaled when executing a storage command. The channel flashes once as feedback in the configured flashing time. Parameter activated: When a storage function is executed, the visual feedback is activated immediately. The output switches to the opposite switching state for the duration of the configured flashing time and then back to the saved scene command. Parameter deactivated: When storing a scene, the visual feedback is not executed. The actuator adopts the current switching state of the output without special feedback. | |

| | |
|---|------------|
| Flashing time (0...10) | 0...5...10 |
| The flashing time in which the visual feedback is to be executed is set here. This parameter is only visible when visual feedback is used. | |

| | |
|--|---------------------|
| Overwrite values stored in the device during the ETS programming operation | Checkbox (yes / no) |
| During storage of a scene, the scene values (current states of the switching outputs concerned) are stored internally in the device. To prevent the stored values from being replaced during ETS programming by the originally programmed scene values, the actuator can inhibit overwriting of the scene values (parameter deactivated). As an alternative, the original values can be reloaded into the device during each programming run of the ETS (parameter activated). | |

| | |
|--|--|
| Use extended scene recall | Checkbox (yes / no) |
| <p>The extended scene recall allows recalling of up to 64 scenes of the switching output in sequence. Here, scene recall takes place via the 1-bit communication object "Extended scene recall". Each ON telegram received via this object recalls the next scene. Each OFF telegram received recalls the previous scene.</p> <p>This parameter enables extended scene recall, if required.</p> | |
| With overflow | Checkbox (yes / no) |
| <p>The extended scene recall can take place with or without an overflow at the scene limits. An overflow occurs when the last scene of the selected configuration is reached when counting up or scene 1 when counting down and an additional telegram in the last counting direction is received by the actuator.</p> <p>Parameter activated: After reaching the last scene of the selected configuration, a further ON telegram of the overflow is executed and scene 1 is recalled. Similarly, after reaching scene 1, the overflow is executed by further OFF telegram and the last scene of the selected configuration is recalled.</p> <p>Parameter deactivated: A scene overflow is not possible. After reaching the last scene of the selected configuration, further ON telegrams of the extended scene recall are ignored. In the same way, the actuator ignores further OFF telegrams if scene 1 was recalled last.</p> <p>This parameter is only visible when the extended scene recall is used.</p> | |
| Scene configuration | variable (1...64 scenes) fixed (64 scenes) |
| <p>The scene configuration selected here decides whether the number of scenes is either variable (1 ... 64) or alternatively fixed to the maximum (64).</p> <p>variable (1...64 scenes): With this setting, the number of scenes used can be selected anywhere in the range 1 to 64. The parameter "Number of scenes" decides how many scenes are visible for the switching output in the ETS and can therefore be used. It is possible to specify which scene number (1 ... 64) controls each scene.</p> <p>fixed (64 scenes): With this setting, all scenes are always visible and can therefore be used. The scenes are controlled via permanently assigned scene numbers (1 ... 64) (scene number 1 -> scene 1, scene number 2 -> scene 2 ...). If necessary, individual scenes can be deactivated.</p> | |
| Number of scenes (1...64) | 1...10...64 |
| <p>This parameter is only available with variable scene configuration and defines how many scenes are visible for the switching output in the ETS and can therefore be used.</p> | |

| | |
|---|---|
| Scene number | 0...1*...64 *: The predefined scene number is dependent on the scene (1...64). |
| <p>With variable scene configuration, the number of scenes used can be selected anywhere in the range 1 to 64. It is then possible to preset which scene number (1 ... 64) controls each scene.</p> <p>A setting of "0" deactivates the corresponding scene so that neither recalling nor storage is possible. If the same scene number is configured for several scenes, only the scene with the lowest sequential number will be addressed. The other scenes will be ignored in this case.</p> <p>This parameter is only available with variable scene configuration.</p> | |
| Scene active | Checkbox (yes / no) |
| <p>With a fixed scene configuration, individual scenes can be activated or deactivated. Only activated scenes can be used. A deactivated scene cannot be recalled or stored via the scene extension.</p> <p>This parameter is only available with fixed scene configuration.</p> | |
| Switching state | ON OFF |
| <p>This parameter is used for configuring the switching state which is set when the scene is recalled.</p> | |
| Memory function | Checkbox (yes / no) |
| <p>If the parameter is activated, the storage function of the scene is enabled. The current switching state can then be stored internally via the extension object on receipt of a storage telegram. If the parameter is deactivated, the storage telegrams are rejected.</p> | |

8.9.2 Scene function objects

| Object no. | Function | Name | Type | DPT | Flag |
|---|-----------------------|----------------------|---------|--------|-----------------|
| 25 | Scene extension | Switching... - Input | 1 bytes | 18,001 | C, (R), W, -, A |
| 1-byte object for polling or saving a scene. | | | | | |
| Object no. | Function | Name | Type | DPT | Flag |
| 26 | Extended scene recall | Switching... - Input | 1-bit | 1,001 | C, (R), W, -, A |
| <p>1-bit object for extended scene recall. Each ON telegram received recalls the next scene of the switching output in sequence. Each OFF telegram received recalls the previous scene.</p> <p>After a reset (bus voltage return, ETS programming operation), an ON or OFF telegram always recalls scene 1 first.</p> | | | | | |

8.10 Disabling function and forced position

Setting forced position function

The forced position function can also be combined with other functions of a switching output. With an active forced position, functions with a lower priority are overridden so that the switching output concerned is locked.

The forced position function possesses a separate 2-bit communication object. The first bit (Bit 0) of the object "Forced position" indicates whether the switching output is switched off or switched on by force. The second bit (bit 1) activates or deactivates the forced-position state (see table below).

The behaviour of a switching output at the end of the forced position can be configured. In addition, the forced object can be initialised on bus voltage return.

| Bit 1 | Bit 0 | Function |
|-------|-------|--|
| 0 | x | Forced position not active -> normal control |
| 1 | 0 | Forced position active: switch off |
| 1 | 1 | Forced position active: switch on |

Table 2: Bit coding of forced position

- On the parameter page "Relay output... -> SO... - General -> Enabled functions" Set the parameter "disabling function" to "forced position".

The forced position function is enabled. The communication object "forced position" and the parameter of the forced position function on the parameter page "Relay output... -> SO... - General -> Forced position" become visible.

- Set the parameter "forced position end 'inactive'" to the required behaviour.

At the end of the forced position, the configured behaviour will be executed and the bus operation of the switching output enabled again.

In the "No change of switching state" setting, the relay of the output shows no reaction and remains in the state last set by the forced position.

In the "Track switching state", the state received during the forced position function or the switching state set before the function can be tracked at the end of the forced position. Any time functions still in progress will also be taken into account if necessary.

- i** Updates of the forced position object from "Forced position active" to "Forced position active" while maintaining the switching status or from "Forced position inactive" to "Forced position inactive" show no reaction.

- i** A switching output forcibly activated via the KNX can be still be operated manually!

- i** In the setting "Track switching state" at the end of the forced position: During a forced position, the overridden functions of the actuator (switching, scenes) continue to be executed internally. Consequently, newly received bus telegrams are evaluated and time functions are triggered as well. At the forced end, the tracked states are set.

- i** The current state of the forced position object will be stored in case of bus voltage failure.
- Set the parameter "After bus voltage return" to the required behaviour.
After bus voltage return, the configured state is transferred to the "Forced position" communication object. When a forced position is activated, the switching output is immediately activated and interlocked accordingly by forced control after bus voltage return until a forced position is enabled via the KNX. The parameter "After bus voltage return" on the parameter page "Relay output... -> SO... - General" is not evaluated for the affected switching output in this case.

In the "state before bus voltage failure" setting, the forced position state last selected and internally stored before bus voltage failure will be tracked after bus voltage return. An ETS programming operation deletes the stored state (reaction in that case same as with "no forced position active").

If the tracked state corresponds to "No forced position", the force-independent parameter "After bus voltage return" (parameter page "Relay output... -> SO... - General") will be executed on return of bus voltage.
- i** After programming the application or parameters with the ETS, the forced position function is always deactivated (object value "0").

A disabling function, or alternatively, a forced position function can be configured for the switching output. In this respect, only one of these functions can be enabled for the switching output.

Setting forced position function

The forced position function can also be combined with other functions of the switching output. With an active forced position, functions with a lower priority are overridden so that the switching output concerned is locked.

The forced position function possesses a separate 2-bit communication object. The first bit (Bit 0) of the object "Forced position" indicates whether the switching output is switched off or switched on by force. The second bit (bit 1) activates or deactivates the forced-position state (see table below).

The behaviour of a switching output at the end of the forced position can be configured. In addition, the forced object can be initialised on bus voltage return.

| Bit 1 | Bit 0 | Function |
|-------|-------|--|
| 0 | x | Forced position not active -> normal control |
| 1 | 0 | Forced position active: switch off |
| 1 | 1 | Forced position active: switch on |

Table 3: Bit coding of forced position

- On the parameter page "Relay output... -> SO... - General -> Enabled functions" Set the parameter "disabling function" to "forced position".
The forced position function is enabled. The communication object "forced position" and the parameter of the forced position function on the parameter page "Relay output... -> SO... - General -> Forced position" become visible.

- Set the parameter "forced position end 'inactive'" to the required behaviour. At the end of the forced position, the configured behaviour will be executed and the bus operation of the switching output enabled again.

In the "No change of switching state" setting, the relay of the output shows no reaction and remains in the state last set by the forced position.

In the "Track switching state", the state received during the forced position function or the switching state set before the function can be tracked at the end of the forced position. Any time functions still in progress will also be taken into account if necessary.

- i** Updates of the forced position object from "Forced position active" to "Forced position active" while maintaining the switching status or from "Forced position inactive" to "Forced position inactive" show no reaction.
- i** A switching output forcibly activated via the KNX can be still be operated manually!
- i** In the setting "Track switching state" at the end of the forced position: During a forced position, the overridden functions of the actuator (switching, scenes) continue to be executed internally. Consequently, newly received bus telegrams are evaluated and time functions are triggered as well. At the forced end, the tracked states are set.
- i** The current state of the forced position object will be stored in case of bus voltage failure.
- Set the parameter "After bus voltage return" to the required behaviour. After bus voltage return, the configured state is transferred to the "Forced position" communication object. When a forced position is activated, the switching output is immediately activated and interlocked accordingly by forced control after bus voltage return until a forced position is enabled via the KNX. The parameter "After bus voltage return" on the parameter page "Relay output... -> SO... - General" is not evaluated for the affected switching output in this case.

In the "state before bus voltage failure" setting, the forced position state last selected and internally stored before bus voltage failure will be tracked after bus voltage return. An ETS programming operation deletes the stored state (reaction in that case same as with "no forced position active").

If the tracked state corresponds to "No forced position", the force-independent parameter "After bus voltage return" (parameter page "Relay output... -> SO... - General") will be executed on return of bus voltage.
- i** After programming the application or parameters with the ETS, the forced position function is always deactivated (object value "0").

8.10.1 Disabling function and forced position parameters

General -> General switching output

| | |
|--|----------------------------------|
| Time for flashing the disabling functions | 1 s 2 s 5 s 10 s |
| The switching output can flash in the disabled state (cyclical switching on and off). The flashing time is configured here. | |

Relay output... -> SO... - General -> Enabled functions

| | |
|---|--|
| Disabling function / Forced position | no selection disabling function forced position |
| It can be defined here whether a disabling function or a forced position for the switching output should be available. The disabling function is only configurable as an alternative to the forced position function. | |

Relay output... -> SO... - General -> Disabling function

| | |
|--|--|
| Acknowledgment | Checkbox (yes / no) |
| <p>The deactivation of the disabling function can optionally take place using an additional 1-bit acknowledgement object. This prevents the deactivation of the disabling function by the disabling object. Alternatively, the acknowledgement object is not available. In this case, disabling is deactivated via the disabling object.</p> <p>Parameter activated: The acknowledgement object is available. The disabling function can only be deactivated using the acknowledgement object by an ON telegram. Telegrams to the disabling object according to the "Deactivate disabling" polarity are ignored by the actuator.</p> <p>Parameter deactivated: No additional acknowledgement object is available. The disabling function is deactivated by the disabling object according to the set polarity.</p> | |
| Polarity of the disabling object | 0 = disabled; 1 = enabled 1 = enabled; 0 = disabled |
| This parameter defines the polarity of the disabling object. This parameter is visible only if the disabling function is enabled. | |

| | |
|---|---|
| Beginning of the disabling function | no change to the switching state switch off switch on flashing |
| <p>The behaviour of the switching output at the beginning of the disabling function can be configured.</p> <p>This parameter is visible only if the disabling function is enabled.</p> <p>no change of switching state: The relay of the output shows no reaction and remains in the switching state last set (switching state in acc. with last non-inverted feedback telegram).</p> <p>Switch off: At the beginning of the disabling function, the switching output is switched off and locked.</p> <p>Switch on: At the beginning of the disabling function, the switching output is switched on and locked.</p> <p>Flash: The switching output is switched on and off cyclically during the disabling. The "time for flashing" is generally configured for all outputs on the parameter page "General switching outputs". During flashing, the logical switching state of the switching output is fed back as "Switched on".</p> | |
| End of the disabling function | no change to the switching state switch off switch on set tracked state flashing |
| <p>The behaviour of the switching output at the end of the disabling function can be configured.</p> <p>This parameter is visible only if the disabling function is enabled and acknowledgement is not used.</p> <p>no change of switching state: The relay of the output shows no reaction and remains in the state last set by the disabling function.</p> <p>Switch off: At the end of the disabling function, the switching output is switched off and enabled again.</p> <p>Switch on: At the end of the disabling function, the switching output is switched on and enabled again.</p> <p>Set tracked state: The last switching state received during the disabling function or the switching state set before the disabling function will be tracked. Any time functions still in progress will also be taken into account if necessary.</p> <p>Flash: The switching output is switched on and off cyclically after the disabling. The time for flashing is generally configured for all outputs on the parameter page "General -> General switching outputs". During flashing, the logical switching state of the output is fed back as "Switched on". The flashing state remains active until another KNX command is received and thereby predefines another switching state.</p> | |

| | |
|--|---|
| End of the disabling function after acknowledgement | no change to the switching state switch off switch on set tracked state flashing |
| <p>The behaviour of the switching output at the end of the disabling function after acknowledgement can be configured.</p> <p>This parameter is visible only if the disabling function is enabled and acknowledgement is used.</p> <p>no change of switching state: The relay of the output shows no reaction on acknowledgement and remains in the state last set by the disabling function.</p> <p>Switch off: On acknowledgement, the switching output is switched off and enabled again.</p> <p>Switch on: On acknowledgement, the switching output is switched on and enabled again.</p> <p>Set tracked state: On acknowledgement, the last switching state received during the disabling function or the switching state set before the disabling function will be tracked. Any time functions still in progress will also be taken into account if necessary.</p> <p>Flash: The switching output is switched on and off cyclically after the acknowledgement. The time for flashing is generally configured for all outputs on the parameter page "General -> General switching outputs". During flashing, the logical switching state of the output is fed back as "Switched on". The flashing state remains active until another KNX command is received and thereby predefines another switching state.</p> | |

Relay output... -> SO... - General -> Forced position

| | |
|--|-------------------|
| Forced position "active, switch on" | switch on |
| <p>If the forced position is activated and restraint is "ON", the switching output is always switched on.</p> <p>This parameter cannot be edited and is only visible when the forced position function is enabled.</p> | |
| Forced position "active, switch off" | switch off |
| <p>If the forced position is activated and forced-position state is "OFF", the switching output is always switched off.</p> <p>This parameter cannot be edited and is only visible when the forced position function is enabled.</p> | |

| | |
|--------------------------------|--|
| Forced position end "inactive" | tracking the switching state no change to the switching state switch off switch on |
|--------------------------------|--|

The behaviour of the switching output at the end of the forced-position can be configured here.

This parameter is only visible when the forced position function is enabled.

Track switching state: The state received during the forced position function or the switching state set before the function can be tracked at the end of the forced position. Any time functions still in progress will also be taken into account if necessary.

No change of switching state: The relay of the output shows no reaction and remains in the state last set by the forced position.

Switch off: At the end of the forced position, the switching output is switched off and enabled again.

Switch on: At the end of the forced position, the switching output is switched on and enabled again.

| | |
|--------------------------|--|
| After bus voltage return | no forced position Forced position active, switch on Forced position active, switch off state before bus voltage failure |
|--------------------------|--|

The forced position communication object can be initialised after bus voltage return. The switching state of the output can be influenced when the forced position function is being activated.

This parameter is only visible when the forced position function is enabled.

No forced position: In case of bus voltage return, the force-independent parameter "After bus voltage return" (parameter page "Relay output... -> SO... - General") will be executed on return of bus voltage.

Forced position active, switch on: The forced position is activated. The switching output is switched on under forced control.

Forced position active, switch off: The forced position is activated. The switching output is switched off under forced control.

State before bus voltage failure: The forced position state last selected and internally stored before bus voltage failure will be tracked after bus voltage return. An ETS programming operation deletes the stored state (reaction in that case same as with "no forced position active"). If the tracked state corresponds to "No forced position", the force-independent parameter "After bus voltage return" (parameter page "Relay output... -> SO... - General") will be executed on return of bus voltage.

8.10.2 Disabling function and forced position objects

| Object no. | Function | Name | Type | DPT | Flag |
|------------|-----------|----------------------|-------|-------|-----------------|
| 27 | Disabling | Switching... - Input | 1-bit | 1,003 | C, (R), W, -, A |

1-bit object for disabling the switching output (polarity configurable).

| Object no. | Function | Name | Type | DPT | Flag |
|------------|-----------------|----------------------|-------|-------|-----------------|
| 28 | forced position | Switching... - Input | 2-bit | 2,001 | C, (R), W, -, A |

2-bit object for the forced position of the switching output. The polarity is fixed by the telegram.

| Object no. | Function | Name | Type | DPT | Flag |
|------------|--------------------------|----------------------|-------|-------|-----------------|
| 35 | Disabling acknowledgment | Switching... - Input | 1-bit | 1,016 | C, (R), W, -, A |

1-bit object to acknowledge an active disabling function of the switching output. This object is only visible if the acknowledgement is to be used with the disabling function ("1" = Disabling function is deactivated / "0" = disabling function remains active).

8.11 Logic operation function

A logic function can be configured separately for the switching output. This function allows the logic operation of the "Switching" object state and an additional logic operation object. The state of the communication object for "switching" can also be evaluated with a time delay if a switch-on delay or switch-off delay is set.

The logic function can also be combined with other functions of a switching output. A combination with the staircase function is not possible, however.

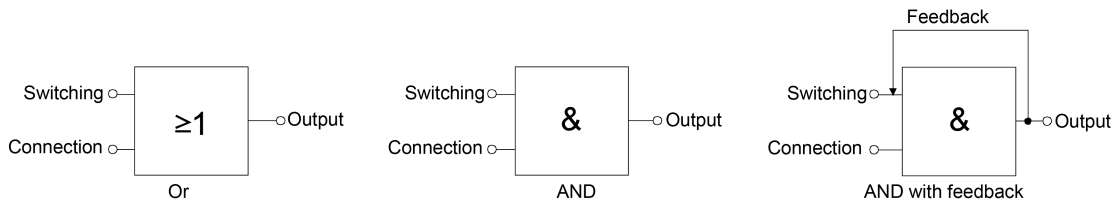

Image 10: Logic operation types of the logic operation function

i "AND with feedback":

With a logic object = "0", the switching output is always "0" (logic AND). In this case, the feedback signal from the output to the "switching" input will directly reset this input when it is being set. The output of the switching output can assume the logical state "1" by a newly received "1" on the input "switching" only when the logic object is = "1".

The object "Logic operation" can be initialised with a configured value after bus voltage return or after an ETS programming operation so that a correct logic operation result can be determined immediately and set on the output of the switching output during a telegram update on the "Switching" object.

- On the parameter page "Relay output... -> SO... - General -> Enabled functions" activate the "logic operation function".

The logic operation function is enabled. The communication object "logic operation" and the parameters of the logic operation function on the parameter page "Relay output... -> SO... - General -> Logic operation function" become visible.

- Set the parameter "Type of logic operation function" to the desired logic operation type.
- Set the parameters "object value after bus voltage return" and "object value after ETS programming" to the required initial states.

The "logic operation" object is initialised immediately with the set switching states after bus voltage return or ETS programming of the application program or parameters.

i The logic operation function after a reset of the actuator (bus voltage return or ETS programming operation) is first executed when the switching object is updated as the input of the logic operation by at least one telegram.

i The states or switching states specified at the end of a disabling function or forced position function, which are set after programming in the ETS, in the case of bus voltage failure or after bus or mains voltage return, override the lo-

gic operation function. The configured logic operation is first re-executed and the result set on the switching output when the switching object is updated as the input of the logic operation by at least one telegram.

8.11.1 Logic operation function parameters

Relay output... -> SO... - General -> Enabled functions

| | |
|---|---------------------|
| Logic operation function | Checkbox (yes / no) |
| <p>The logic operation function can be enabled here. The parameter is deactivated and unchangeable if the staircase function or cyclical monitoring is enabled.</p> | |

Relay output... -> SO... - General -> Logic operation function

| | |
|--|---|
| Type of logic operation function | OR AND AND with feedback |
| <p>This parameter defines the logical type of the logic operation function. The object "logic operation" is linked to the logic switching state of the switching output (object "switching" after evaluation of configured time delays if necessary) using the logic operation function set here. This parameter is only visible when the logic operation function is enabled.</p> | |
| Object value after bus voltage return | 0 (OFF) 1 (ON) |
| <p>After bus voltage return, the object value of the logic operation object is initialised here with the preset value. This parameter is only visible when the logic operation function is enabled.</p> | |
| Object value after ETS download | 0 (OFF) 1 (ON) |
| <p>After programming the application or the parameters in the ETS, the object value of the logic operation object is initialised here with the preset value. This parameter is only visible when the logic operation function is enabled.</p> | |

8.11.2 Logic operation function objects

| Object no. | Function | Name | Type | DPT | Flag |
|--|-----------------|----------------------|-------|-------|-----------------|
| 21 | Logic operation | Switching... - Input | 1-bit | 1,002 | C, (R), W, -, A |
| <p>1-bit object as input of the logical link of the switching output. After bus voltage return or after programming with the ETS, the object value can be predefined for each parameter.</p> | | | | | |

8.12 Operating hours counter

The operating hours counter determines the switch-on time of a switching output. For the operating hours counter, an output is actively on when the relay contact is closed, i.e. when current is flowing to the load. In consequence, a closed contact is always evaluated, irrespective of the set relay operating mode (NO or NC contact) and the logical feedback of the switching status.

The operating hours counter can either be configured as a second counter or alternatively as an hour counter.

- Second counter

The actuator adds up the determined switch-on time accurately to the second for a closed relay contact. The totalled operating seconds are added in a 4-byte counter and stored permanently in the device. The current counter reading can be transmitted cyclically to the KNX by the "Value operating hours counter reading" communication object or when there is a change in an interval value in acc. with DPT 13.100.

- Second counter

The actuator adds up the determined switch-on time accurately to the minute for a closed relay contact in full operating hours. The totalled operating hours are added in a 2-byte meter and stored permanently in the device. The current counter reading can be transmitted cyclically to the KNX by the "Value operating hours counter" communication object or when there is a change in an interval value in acc. with DPT 7.007.

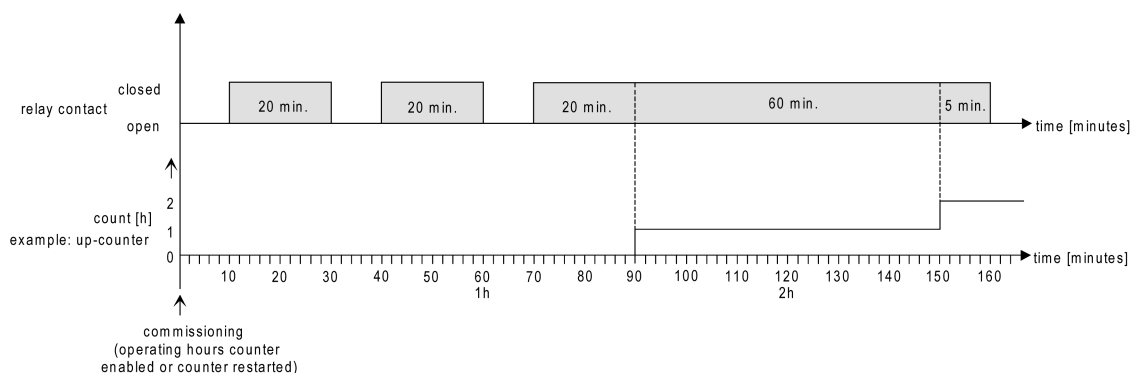

Image 11: Function of the operating hours counter (using the example of counted hours)

In the delivery state, all values of the actuator are "0". If the operating hours counter is not enabled in the configuration of an output, no operating hours or operating seconds will be counted for the output concerned. Once the operating hours counter is enabled in the ETS, however, the operating hours or operating seconds will be determined and added up by the ETS immediately after commissioning the actuator. If the operating hours counter is subsequently disabled again in the parameters and the actuator is programmed with this disabling function, all the operating hours or operating seconds previously counted for the output concerned will be deleted. When enabled again, the meter reading of the operating hours counter is always on "0 h".

The operating hours values (full hours) or operating seconds stored in the device will not be lost in case of a bus voltage failure or by ETS programming.

On the hour counter: Any summed up operating minutes (full hour not yet reached) will be rejected in this case, however.

After bus voltage return or after an ETS programming operation, the actuator passively updates the "Value operating hours counter" communication object in each output. The object value can be read out if the read-flag is set. The object value, depending on the configuration for the automatic transmission, is actively transmitted if necessary to the KNX once the configured transmission delay has elapsed after bus voltage return (see "Set transmission behaviour of the operating hours counter").

Activating the operating hours counter

- On the parameter page "Relay output... -> SO... - General -> Enabled functions" activate the parameter "operating hours counter".

The operating hours counter is activated.

- Deactivate the operating hours counter".

The operating hours counter is deactivated.

-  Disabling of the operating hours counter and subsequent programming with the ETS resets the counter status to "0".

Setting the counter type

The operating hours counter can optionally be configured as an up-counter or down-counter. Depending on this type of counter, a limit or start value can be set optionally, whereby, for example, the operating time of a lamp can be monitored by restricting the counter range.

Up-counter:

After activating the operating hours counter by enabling in the ETS or by restarting, the operating hours are counted starting at "0". A maximum of 65,535 hours or 2147483647 can be counted (corresponds to approx. 66 years), after that the counter stops and signals a counter operation via the "Operating hours count. elapsed" object.

A limiting value can be set optionally in the ETS or can be predefined via the communication object "Limiting value operating hours counter". In this case, the counter operation is signaled to the KNX via the "Operating hours count. elapsed" object if the limiting value is reached, but the counter continues counting - if it is not restarted - up to the maximum value and then stops. Only a restart initiates a new counting operation.

Down-counter:

After enabling the operating hours counter in the ETS, the meter reading is on "0 h" and the actuator signals a counter operation for the output concerned after the programming operation or after bus voltage return via the "Operating hours count. elapsed" object. Only after a restart is the down-counter set to the maximum value of 65,535 hours or 2147483647 seconds (corresponds to approx. 66 years) and the counter operation is started.

A start value can be set optionally in the ETS or can be predefined via the communication object "start value operating hours counter". If a start value is set, the down-counter is initialised with this value instead of the maximum value after a restart. The meter then counts the start value downwards by the hour. When the down-counter reaches the value "0", the counter operation is signalled to the KNX via the "Operating hours count. elapsed" and the counting is stopped. Only a restart initiates a new counting operation.

The operating hours counter must be enabled on the parameter page "Relay output... -> SO... - General -> Enabled functions".

- Set the parameter "Counter type" on the parameter page "Relay output... -> SO... - General -> Operating hours counter" to "Up counter". Set the parameter "Limiting value presetting" to "yes, as specified in parameter" or "yes as received via object" if it is necessary to monitor the limiting value. Otherwise, reset the parameter to "no". In the "Yes, as specified in parameter" setting, specify the required limit value.

The meter counts the operating hours forwards starting from "0 h". If the monitoring of the limiting value is activated, the actuator transmits an "ON"-telegram via the object "Operating hours count. elapsed" for the output concerned once the predefined limiting value is reached. Otherwise, the counter operation is first transmitted when the maximum value is reached.

- Set the parameter "Counter type" to "Down-counter". Set the parameter "Start value preset" to "yes, as parameter" or "yes, as received via object" if a start value preset is necessary. Otherwise, reset the parameter to "no". In the "yes, as specified in parameter" setting, specify the required start value.

The meter counts the operating hours down to "0 h" after a restart. With a start value preset, the start value is counted down, otherwise the counting operation starts at the maximum value. The actuator transmits an "ON"-telegram via the object "Operating hours count. elapsed" for the output concerned once the value "0" is reached.

i The value of the communication object "Operating hours count. elapsed" is stored permanently. On switching on the bus voltage or after an ETS programming operation, the object is initialised with the most recently saved value. If an operating hours counter is in this case identified as elapsed, i.e. if the object value is a "ON", an additional telegram will be actively transmitted to the KNX as soon as the configured transmit delay has elapsed after bus voltage return. If the counter has not yet elapsed (object value (object value "OFF"), no telegram is transmitted on bus voltage return or after an ETS programming operation.

i With a limiting or start value preset via communication object: The values received via the object are first validly accepted and permanently saved internally after a restart of the operating hours counter. On switching on the bus voltage or after an ETS programming operation, the object is initialised with the most recently saved value. The values received will be lost in the case of a bus voltage failure or by an ETS programming operation if no counter restart was executed before. For this reason, when specifying a new start or limiting

value it is advisable to always execute a counter restart afterwards as well. A standard value of 65,535 hours or 2147483647 seconds is predefined provided that no limiting value or start value has been received yet via the object. The values received and stored via the object are reset to the standard value if the operating hours counter is disabled in the parameters of the ETS and an ETS programming operation is being performed.

- i** With a limiting or start value predefined via object: If the start or limiting value is predefined with "0", the actuator will ignore a counter restart to avoid an undesired reset (e.g. in site operation -> hours already counted by manual operation).
- i** If the counter direction of an operating hours counter is reversed by reconfiguration in the ETS, a restart of the meter should always be performed after programming the actuator so that the meter is reinitialised.

Restarting the operating hours counter

The meter reading of the operating hours can be reset at any time by the communication object "Restart operating hours counter". The polarity of the reset telegram is predefined: "1" = Restart / "0" = No reaction.

In the up-counter the meter is initialised with the value "0" after a restart and in the down-counter initialised with the start value. If no start value was configured or predefined by the object, the start value is preset to 65535 hours or 2147483647 seconds.

During every counter restart, the initialised meter reading is transmitted actively to the KNX.

After a restart, the signal of a counter operation is also reset. At the same time, an "OFF" telegram is transmitted to the KNX via the object "Operating hours count elapsed". In addition, the limiting or start value is initialised.

- i** If a new limiting or start value was predefined via the communication object, a counter restart should always be performed afterwards, too. Otherwise, the values received will be lost in the case of a bus voltage failure or by an ETS programming operation.
- i** If a start or limiting value is predefined with "0", there are different behaviours after a restart, depending on the principle of the value definition...
 - Preset as parameter:
The counter elapses immediately after a counter restart.
 - Preset via object:
A counter restart will be ignored to avoid an undesired reset. A limiting or start value greater than "0" must be predefined in order to perform the restart.

Setting the transmission behaviour

The current value of the operating hours counter is tracked continuously in the communication object "value operating hours counter". The content of the object is transmitted to the KNX when there is a change by the set count interval or cyclically active. The object value can also be read out at any time (set read flag).

The operating hours counter must be enabled on the parameter page "Relay output... -> SO... - General -> Enabled functions".

- Set the parameter "Automatic transmission of counter value" on parameter page "Relay output... -> SO... - General -> Operating hours counter" to "After change by interval value". Set the "Counting value interval" to the desired value.

The meter reading is transmitted to the KNX as soon as it changes by the pre-defined counting value interval. After bus voltage return or after ETS programming operation, the object value is transmitted automatically after "Delay after bus voltage return" has elapsed if the current counter status or a multiple of this corresponds to the counting value interval. A counter status "0" is always transmitted in this case.

- Set the parameter "Automatic transmission of counting value" to "Cyclical".
The counter value is transmitted cyclically. The cycle time is defined via the parameter of the same name. After bus voltage return or an ETS programming operation, the counter status is only transmitted to the KNX after the configured cycle time has elapsed.

8.12.1 Operating hours counter parameters

Relay output... -> SO... - General -> Enabled functions

| | |
|--|---------------------|
| Operating hours counter | Checkbox (yes / no) |
| The operating hours counter can be disabled or enabled here. | |

Relay output... -> SO... - General -> Operating hours counter

| | |
|----------|--|
| Function | second counter (DPT 13.100) hour counter (DPT 7.007) |
|----------|--|

The operating hours counter can either be configured as a second counter or alternatively as an hour counter.

Second counter: The actuator adds up the determined switch-on time accurately to the second for a closed relay contact. The totaled operating seconds are added in a 4-byte counter and stored permanently in the device. The current counter reading can be transmitted cyclically to the KNX by the "Value operating hours counter reading" communication object or when there is a change in an interval value in acc. with DPT 13.100.

Hour counter: The actuator adds up the determined switch-on time accurately to the minute for a closed relay contact in full operating hours. The totaled operating hours are added in a 2-byte meter and stored permanently in the device. The current counter reading can be transmitted cyclically to the KNX by the "Value operating hours counter" communication object or when there is a change in an interval value in acc. with DPT 7.007.

| | |
|-----------------|-----------------------------------|
| Type of counter | up-counter down-counter |
|-----------------|-----------------------------------|

The operating hours counter can be configured as an up-counter or down-counter. The setting here influences the visibility of the other parameters and objects of the operating hours counter.

| | |
|---------------------------|--|
| Limiting value presetting | no yes, as specified in parameter yes, as received via object |
|---------------------------|--|

If the up-counter is used, a limiting value can optionally be predefined. This parameter defines whether the limiting value can be set via a separate parameter or adapted individually by a communication object from the bus. The "No" setting deactivates the limiting value.

This parameter is only visible in the configuration "Type of counter = up-counter".

| | |
|---|---|
| Limiting value (s)* | 0...2147483647* |
| Limiting value (h)** | 0...65535** |
| <p>The limiting value of the up-counter is set here. Once the limiting value is reached, an "ON" telegram is transmitted via the object "Operating hours count elapsed". The counter itself continues until the maximum counter status is reached and then stops.</p> <p>*: With second counter **: With hour counter</p> <p>This parameter is only visible if the parameter "Limiting value presetting" is set to "yes, as specified in parameter".</p> | |
| Start value preset | no yes, as specified in parameter yes, as received via object |
| <p>If the down-counter is used, a start value can optionally be predefined. This parameter defines whether the start value can be set via a separate parameter or adapted individually by a communication object from the bus. The setting "No" deactivates the start value.</p> <p>This parameter is only visible in the configuration "Type of counter = down-counter".</p> | |
| Start value (s)* | 0...2147483647* |
| Start value (h)** | 0...65535** |
| <p>The start value of the down-counter is set here. After the initialisation, the counter starts counting down the predefined value by the hour until the value "0". If this end value is reached, an "ON" telegram is transmitted via the object "Operating hours count elapsed"</p> <p>*: With seconds counter **: With hour counter</p> <p>This parameter is only visible if the parameter "Start value preset" is set to "yes, as specified in parameter".</p> | |
| Transmission behaviour of the counter value | cyclical after change by interval value |
| <p>The current meter reading of the operating hours counter can be transmitted actively to the KNX via the "value operating hours counter" communication object.</p> <p>Cyclically: The counter reading is transmitted cyclically to the KNX and when there is a change.</p> <p>After change by interval value: The counter reading is transmitted to the KNX only when there is a change.</p> | |
| Time for cyclical transmission hours (0...23) | 0...23 |
| <p>This parameter defines the cycle time for the cyclical transmission. Setting the cycle time hours.</p> | |

| | |
|---|---|
| Minutes (0...59) | 0...15...59 |
| Setting the cycle time minutes. | |
| Seconds (10...59) | 10...59 |
| Setting the cycle time seconds. This parameter for the cycle time is only visible when parameter "Transmission behaviour of the counter value" is set to "cyclically". | |
| Counter value interval | 0...3600...2147483647* 0...1...65535** |
| The interval of the counter value is set here for automatic transmission. The current counter reading is transmitted to the KNX after the time interval configured here. *: With second counter **: With hour counter This parameter is only visible when parameter "Transmission behaviour of the counter value" is set to "On change by interval value". | |

8.12.2 Operating hours counter objects

| Object no. | Function | Name | Type | DPT | Flag |
|---|--|-----------------------|---------|--------|-----------------|
| 239 | Limiting value / starting value, operating hours counter | Switching... - Input | 4 bytes | 13,100 | C, (R), W, -, A |
| <p>4-byte object for external specification of a limit value / starting value of the operating hours counter of the switching output. Value range: 0...2147483647 seconds This object is only available with the second counter.</p> | | | | | |
| Object no. | Function | Name | Type | DPT | Flag |
| 240 | Limiting value / starting value, operating hours counter | Switching... - Input | 2 bytes | 7,007 | C, (R), W, -, A |
| <p>2-byte object for external specification of a limit value / starting value of the operating hours counter of the switching output. Value range: 0...65,535 hours This object is only available with the hour counter.</p> | | | | | |
| Object no. | Function | Name | Type | DPT | Flag |
| 241 | Restart op. hours counter | Switching... - Input | 1-bit | 1,015 | C, (R), W, -, A |
| <p>1-bit object for resetting the operating hours counter of the switching output ("1" = restart, "0" = no reaction).</p> | | | | | |
| Object no. | Function | Name | Type | DPT | Flag |
| 242 | Value operating hours counter | Switching... - Output | 4 bytes | 13,100 | C, R, -, T, A |
| <p>4-byte object to transmit or read out the current counter level of the operating hours counter of the switching output. Value range: 0...2147483647 seconds If the bus voltage should fail, the value of the communication object is not lost and is actively transmitted to the bus after bus voltage return or an ETS programming operation. In the as-delivered state, the value is "0". This object is only available with the second counter.</p> | | | | | |

| Object no. | Function | Name | Type | DPT | Flag |
|------------|-------------------------------|-----------------------|---------|-------|---------------|
| 243 | Value operating hours counter | Switching... - Output | 2 bytes | 7,007 | C, R, -, T, A |

2-byte object to transmit or read out the current counter level of the operating hours counter of the switching output.

Value range: 0...65,535 hours

If the bus voltage should fail, the value of the communication object is not lost and is actively transmitted to the bus after bus voltage return or an ETS programming operation. In the as-delivered state, the value is "0".

This object is only available with the hour counter.

| Object no. | Function | Name | Type | DPT | Flag |
|------------|---------------------------------|-----------------------|-------|-------|---------------|
| 244 | Operating hours counter elapsed | Switching... - Output | 1-bit | 1,002 | C, R, -, T, A |

1-bit object to sign that the operating hours counter has elapsed (forwards counter = limit value reached / backwards counter = value "0" reached). With a message, the object value is actively transmitted to the KNX ("1" = message active / "0" = message inactive).

If the bus voltage should fail, the value of the communication object is not lost and is actively transmitted to the bus after bus voltage return or an ETS programming operation.

9 Inputs

9.1 General settings

Introduction

The device has three inputs with a common reference potential. Potential-free switches, push-buttons or other contacts (e.g. magnetic contacts) or alternatively leakage and dew sensors (accessories) can be connected to these inputs. In addition, it is possible to connect an NTC temperature sensor to input 3 for measuring a floor or room temperature.

Depending on the ETS parameterisation in the application for switches, push-buttons or contacts, the inputs 1 and 2 either act internally on the relay output or alternatively also separately on the KNX. Input 3 always acts on the KNX if required. With internal action, inputs 1 and 2 directly operate the switching output in a defined configuration. With the effect on the KNX, the inputs can transmit individual telegrams for switching or dimming for venetian blind control or value transmitter use (dimming value transmitter, light scene extension, colour or colour temperature value transmitter). They then function like the inputs of a push-button interface.

- i** The internal effect of the inputs 1 on the switching output corresponds to the delivery state (unprogrammed device). This means that a connected load can already be put into operation and operated on the building site just by applying the bus voltage and without the use of further KNX sensors.

Configuration of inputs

The parameter "Inputs act internally on output" on the parameter page "General -> General inputs" defines the use of the inputs.

- Activate the parameter "Inputs act internally on output".
Depending on the "Function" parameter, input 1 and optionally also input 2 act internally directly on the relay output of the unit. The inputs then do not have their own parameters in the application programme.
Input 3 acts separately on the KNX, independently of the relay outputs and the other inputs. Depending on the ETS configuration, the functions "Switching", "Dimming", "Venetian blind", "Value transmitter", "Scene extension", "2-channel operation" and "Controller extension" can be set individually in the application for switches, push-buttons or contacts for input 3. In the "no function" setting, the input 3 is deactivated.
- Deactivate the parameter "Inputs act internally on output".
The three inputs of the device act independently of the relay output and separately from each other on the KNX. Depending on the ETS configuration, the functions "Switching", "Dimming", "Venetian blind", "Value transmitter", "Scene extension", "2-channel operation" and "Controller extension" can be set individually in the application for for each input. With the setting "no function", the corresponding input is deactivated.
In the application for dew and leakage sensors, the inputs are automatically

configured by the application to the function "Switching". An ON telegram is sent on the KNX when the connected sensor is triggered, and an OFF telegram is sent when the sensor is reset. The debounce time is preset to the usable sensors by the parameter of the same name. However, the time can be set individually for each input if necessary. The instructions from the documentation of the dew and leakage sensors must be observed!

If input 3 is used as an input for a temperature sensor, parameters are available in the application program that define the acquisition of the measured value, the temperature adjustment and the transmission behaviour of the temperature value. The wired temperature sensor can be combined with an external temperature value. This makes it possible to form one measured value from up to two measured values.

- i** Only use the dew/leakage sensors and NTC temperature sensors listed in the accessories. Functional errors may occur with other sensors.
- i** The debounce time of the connected switches or push-buttons is always fixed at 30 ms with internal effect on the relay output.
- i** After bus voltage recovery, the inputs show no reaction with internal effect. The intended reaction is only carried out when the signal changes. The device does not react to a change of state of the input signals until the parameterised "Delay after bus voltage return" has elapsed. Within the delay, any pending signals at the inputs are not evaluated and are ignored. In the delivery state the delay after bus voltage recovery is preset to 2 seconds.

The parameter "Functionality" on the parameter page "General -> General inputs" determines how inputs 1 and 2 operate in the event of an internal effect on the relay output. Setting this parameter adjusts the inputs to the connected switches or buttons.

- Functioning of input 1 when the internal switching output is controlled as single-area operation.

In this application, the parameter "Mode of operation" must be set to the setting "Single-area operation (I1 -> SO1)". Input 1 (I1) then acts directly on the switching output (SO1) without KNX communication. In this application, switches or bell pushes can be connected, for example. Input 2 optionally acts on the KNX in this configuration.

| Input | Switch, push-button (NO contact) | Function |
|-------|----------------------------------|----------|
| 1 | Contact closed | SO1 ON |
| 1 | Contact opened | SO1 OFF |

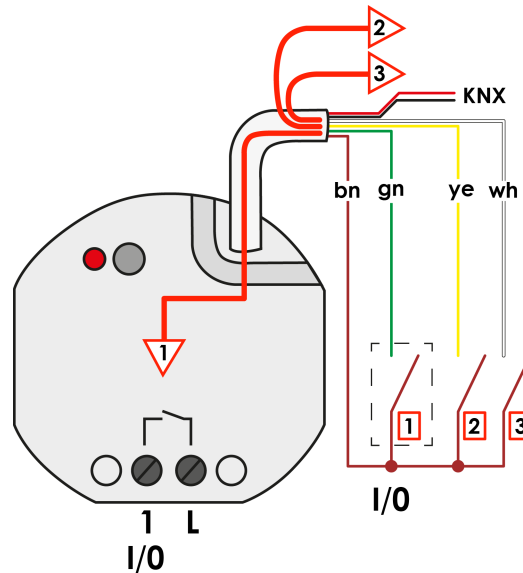

Image 12: Functionality of the input 1 when controlling the internal switching output as single-area operation

- Functioning of inputs 1 and 2 when controlling the internal switching output as dual-area operation

For this purpose, the parameter "Mode of operation" must be set to the setting "Dual-area operation (I1 & I2 -> SO1)". Inputs 1 (I1) and 2 (I2) then act together directly on switching output (SO1) without KNX communication. In this application, for example, a 2-fold rocker switch can be connected.

| Input | Push-button (NO contact) | Function |
|-------|--------------------------|----------|
| 1 | Contact closed | SO1 ON |
| 1 | Contact opened | --- |
| 2 | Contact closed | SO1 OFF |
| 2 | Contact opened | --- |

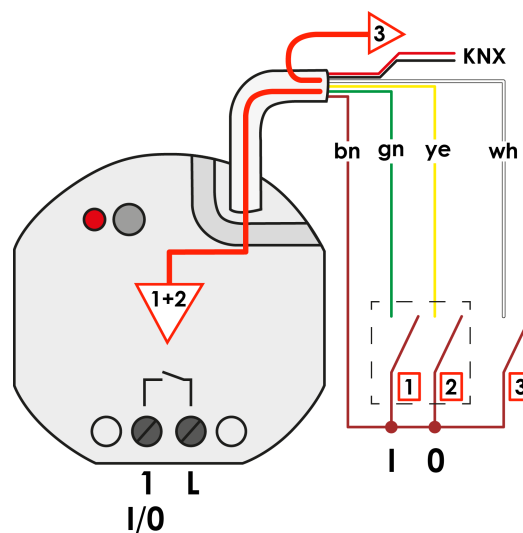

Image 13: Functionality of the inputs when controlling the internal Switching output as dual-area operation

Name of a output

Here, you can optionally assign a name for each input. The name is intended to clarify the use of the input (e.g. "Contact window", "Switch light") and is used exclusively in the ETS in the text of the parameter pages and communication objects.

Delay after bus voltage return

If the inputs act on the KNX, it can be defined separately for each input whether a reaction should take place after a device reset (bus voltage return or ETS programming operation). This means that a defined telegram can be transmitted to the KNX according to the input signal or with forced control. The configured "Delay after bus voltage return" for the inputs on the "General -> General inputs" parameter page must have elapsed fully by the time the set reaction is executed. Within the delay, any pending signals at the inputs are not evaluated and are ignored. The delay time is configured generally for all the inputs.

- i** If a dew or leakage sensor is connected to the inputs, the delay after bus voltage recovery should not be configured to be less than 5 seconds.
- i** In the delivery state the delay after bus voltage recovery is preset to 2 seconds.

9.1.1 Configuration inputs parameters

General -> General inputs

| | |
|--|---------------------|
| Inputs act internally on output | Checkbox (yes / no) |
| <p>Depending on the ETS parameterisation in the application for switches, push-buttons or contacts, the inputs 1 and 2 either act internally on the relay output or alternatively also separately on the KNX. Input 3 always acts on the KNX if required. With internal action, inputs 1 and 2 directly operate the switching output in a defined configuration.</p> <p>This parameter defines the use of the inputs.</p> <p>Parameter activated: Depending on the "Function" parameter, input 1 and optionally also input 2 act internally directly on the relay output of the unit. The inputs then do not have their own parameters in the application programme. Input 3 acts separately on the KNX, independently of the relay outputs and the other inputs.</p> <p>Parameter deactivated: The three inputs of the device act independently of the relay outputs and separately from each other on the KNX.</p> | |

| | |
|---|---|
| Function | single-area operation (I1 -> SO1) dual-area operation (I1 & I2 -> SO1) |
| <p>At this point it is determined how inputs 1 and 2 operate in the event of an internal effect on the relay output. Setting this parameter adjusts the inputs to the connected switches or buttons.</p> <p>Single-area operation (I1 -> SO1): Input 1 (I1) then acts directly on the switching output (SO1) without KNX communication. In this application, switches or bell pushes can be connected, for example. Input 2 optionally acts on the KNX in this configuration.</p> <p>Dual-area operation (I1 & I2 -> SO1): Inputs 1 (I1) and 2 (I2) act together directly on switching output (SO1) without KNX communication. In this application, for example, a 2-fold rocker switch can be connected.</p> | |

| | |
|--|--------|
| Delay after bus voltage return Minutes (0...59) | 0...59 |
| <p>If the inputs act on the KNX, it can be defined separately for each input whether a reaction should take place after a device reset (bus voltage return or ETS programming operation). This means that a defined telegram can be transmitted to the KNX according to the input signal or with forced control. The configured "Delay after bus voltage return" for the inputs on the "General -> General inputs" parameter page must have elapsed fully by the time the set reaction is executed. Within the delay, any pending signals at the inputs are not evaluated and are ignored. The delay time is configured generally for all the inputs.</p> <p>If a dew or leakage sensor is connected to the inputs, the delay after bus voltage recovery should not be configured to be less than 5 seconds.</p> <p>Setting the delay time minutes.</p> | |

| | |
|---------------------------------|------------|
| Seconds (0...59) | 0...5...59 |
| Setting the delay time seconds. | |

Input... -> I... - Function

| Name of input | Free text |
|--|---|
| <p>The text entered in this parameter is adopted in the name of the communication objects and is used to identify the input in the ETS parameter window (e.g. "Contact window", "Switch light").</p> <p>The text is not programmed in the device.</p> | |
| Function | Switches, push-buttons or contacts Dew/leakage sensor Temperature sensor (NTC) |
| <p>Potential-free switches, push-buttons or other contacts (e.g. magnetic contacts) or alternatively leakage and dew sensors (accessories) can be connected to the inputs. In addition, it is possible to connect an NTC temperature sensor to input 3 for measuring a floor or room temperature.</p> <p>switches, push-buttons or contacts: The input acts independently of the relay outputs on the KNX. The functions "Switching", "Dimming", "Venetian blind", "Value transmitter", "Scene extension", "2-channel operation" and "Controller extension" can be set individually. In the "no function" setting, the input is deactivated.</p> <p>Dew/leakage sensor: With this setting, the input is automatically configured by the application to the "Switching" function. An ON telegram is sent on the KNX when the connected sensor is triggered, and an OFF telegram is sent when the sensor is reset. The debounce time is preset to the usable sensors by the parameter of the same name. However, the time can be set individually for each input if necessary. The instructions from the documentation of the dew and leakage sensors must be observed!</p> <p>Temperature sensor (NTC): This setting is only available for input 3. If this setting is selected, input 3 can be used as an input for a temperature sensor. Parameters are then available in the application programme that define the acquisition of the measured value, the temperature adjustment and the transmission behaviour of the temperature value. The wired temperature sensor can be combined with an external temperature value. This makes it possible to form one measured value from up to two measured values.</p> | |

| | |
|---|---|
| Function | No function Switching Dimming Venetian blind Value transmitter Scene extension 2-channel operation Controller extension |
| <p>With the effect on the KNX, the inputs can transmit individual telegrams for switching or dimming for venetian blind control or value transmitter use (dimming value transmitter, light scene extension, colour or colour temperature value transmitter). They then function like the inputs of a push-button interface.</p> <p>The function of the input is specified here.</p> | |

9.2 Switching

For each input whose function is set to "Switching", the ETS displays two 1-bit communication objects. The parameters can be used to determine which value the "Switch" object receives when the contact is closed and opened (ON, OFF, TOGGLE). No distinction is made between a brief or long press. Optionally, when using the "UM" operating command, the "Switching feedback" object can be used to switch the switching state of the input on the part of the KNX (for example, when using several operating devices).

Behaviour after bus voltage return

After a device reset (bus voltage return or ETS programming operation), the communication object "Switching" of an input can be initialised. For this, the "On bus voltage return" parameter should be configured to the required reaction. In the settings "ON telegram" or "OFF telegram" telegrams are transmitted actively to the KNX according to this requirement. In the "Transmit current input status" setting, the device evaluates the static signal status of an input and, according to this, transmits the appropriately configured telegram to the bus (contact closed at the input = telegram as on closing; contact open at input = telegram as on opening). If, in this case, the edge command dependent on the current status is configured to "no reaction", the device does not transmit a telegram on initialisation.

- i** If a delay is set for the inputs after bus voltage return, the device only transmits the telegrams when the delay has elapsed.

9.2.1 Switching parameters

Input... -> I... - Function

| | |
|--|------------------------------------|
| Debounce time (10...255 ms) | 10...255 |
| This parameter sets the debouncing time individually for the input. According to the time set here, the input signal at the input is evaluated with a delay. | |
| When closing the contact | no reaction ON OFF TOGGLE |
| This parameter determines the reaction when the contact connected to the input is closed. | |
| When opening the contact | no reaction ON OFF TOGGLE |
| This parameter determines the reaction when the contact connected to the input is opened. | |

| | |
|--|--|
| After bus voltage return | no reaction Transmit current input status Send ON telegram Send OFF telegram |
| <p>At this point, the behaviour of the input after a device reset (bus voltage return, ETS programming operation) is defined. If a delay after bus voltage return is set for the inputs, the device will not carry out the reaction specified at this point until the delay has expired.</p> <p>no reaction: The device does not send a telegram for initialisation.</p> <p>transmit current input status: With this setting, the device evaluates the static signal status of an input and, according to this, transmits the appropriately configured telegram to the bus (contact closed at the input = telegram as on closing; contact open at input = telegram as on opening).</p> <p>Send ON telegram: The device sends an ON command for the input via the communication object "Switch".</p> <p>Send OFF telegram: The device sends an OFF command for the input via the communication object "Switch".</p> | |

9.2.2 Switching objects

| Object no. | Function | Name | Type | DPT | Flag |
|--|--------------------|-------------------|-------|-------|---------------|
| 471, 474, 477 | Switching | Input... - Output | 1-bit | 1,001 | C, R, -, T, A |
| 1-bit object for transmission of switching telegrams (ON, OFF). | | | | | |
| Object no. | Function | Name | Type | DPT | Flag |
| 472, 475, 478 | Switching feedback | Input... - Input | 1-bit | 1,001 | C, -, W, -, U |
| 1-bit object for receiving feedback telegrams (ON, OFF) from other control points. | | | | | |

9.3 Dimming

For each input whose function is set to "dimming", two 1-bit objects and one 4-bit or one 3-byte object are available. In general, the device sends out a switching telegram when there is a short signal at the input (closed contact) and a dimming telegram when there is a long signal. After a long signal, the device sends a telegram to stop the dimming process in the standard parameterisation when the contact is opened. How long a signal must last until the device recognises it as long can be set in the parameters. The brightness or the colour temperature can be dimmed.

When an actuator is controlled by several control points, it is necessary for the actuator to report its switching status back to the 1-bit object "Switching feedback" of the input. Due to the feedback, the device detects that the actuator has changed its switching status by input from another element and adjusts the dimming direction accordingly.

The dimming direction is always only evaluated and switched locally, unless the actuator changes its switching status due to input from multiple elements (e.g. lighting ON / change of brightness value only). The 4-bit dimming objects and the 3-byte combi object are not tracked via the KNX.

Advanced configuration options

The device has advanced parameters for the dimming function. If necessary, these advanced parameters can be activated and thus be made visible.

The advanced parameters can be used to determine whether the device is to cover the full adjusting range of the actuator with one dimming telegram continuously ("Increase brightness / Dimming colder by 100 %", "Reduce brightness / Dimming warmer by 100 %") or whether the dimming range is to be divided into several small levels (50 %, 25 %, 12.5 %, 6 %, 3 %, 1.5 %). With stepless dimming (100%), the device only sends a telegram at the beginning of a long signal to start the dimming process and usually a stop telegram when the contact at the input opens. For dimming in small levels it may be useful if the device repeats the dimming telegram in case of a sustained signal for a presettable time (parameter "Telegram repetition"). In return, the stop telegram can be omitted when opening the contact.

- i** When the parameters are hidden ("Advanced parameters = deactivated"), the dimming range is set to 100 %, the stop telegram is activated and the telegram repetition is deactivated.

Behaviour after bus voltage return

After a device reset (bus voltage return or ETS programming operation), the communication object "Switching" of an input can be initialised. For this, the "On bus voltage return" parameter should be configured to the required reaction. In the settings "ON telegram" or "OFF telegram" telegrams are transmitted actively to the KNX according to this requirement.

- i** If a delay is set for the inputs after bus voltage return, the device only transmits the telegrams when the delay has elapsed.

9.3.1 Dimming of brightness

In the standard parameterisation, the brightness is dimmed, which is why the "Colour temperature control" parameter is deactivated.

- i** Even with "colour temperature control" activated, the brightness can be dimmed when using the combi object.

The "Dimming" function with the control of the brightness distinguishes between dual-area operation and single-area operation. The "Brightness when closing the contact" parameter defines the single- or dual-surface dimming principle.

| dual-area operation | single-area operation |
|---------------------|----------------------------|
| Brighter (ON) | Brighter / darker (TOGGLE) |
| Darker (OFF) | Brighter (TOGGLE) |
| | Darker (TOGGLE) |

With dual-area operation, the device sends a telegram for switching on or off with a short signal and a telegram for dimming up ("Brighter") or dimming down ("Darker") with a long signal.

With single-area operation, the device sends switch-on and switch-off telegrams ("UM") alternately with a short signal and "Brighter" and "Darker" telegrams alternately with a long signal.

9.3.2 Dimming of colour temperature

When "Colour temperature control" is activated, only the colour temperature can be dimmed via an individual object.

- i** Even with "colour temperature control" activated, the brightness can be dimmed when using the combi object.

The "Dimming" function with the control of the colour temperature distinguishes between dual-area operation and single-area operation. The "Colour temperature when closing the contact" parameter defines the single- or dual-surface dimming principle.

| dual-area operation | single-area operation |
|---------------------|--------------------------|
| Colder (ON) | Colder / warmer (TOGGLE) |
| Warmer (OFF) | Colder (TOGGLE) |
| | Warmer (TOGGLE) |

With dual-area operation, the device sends a telegram for switching on or off with a short signal and a telegram for dimming colder or dimming warmer with a long signal.

With single-area operation, the device sends switch-on and switch-off telegrams ("UM") alternately with a short signal and "Colder" and "Warmer" telegrams alternately with a long signal.

9.3.3 Dimming of brightness and colour temperature

If "colour temperature control" is activated, both the brightness and the colour temperature can be dimmed when using the combi object.

The "Dimming" function with the control of the brightness and colour temperature distinguishes between dual-area operation and single-area operation. The "Brightness + colour temperature when closing the contact" parameter defines the single- or dual-surface dimming principle.

| dual-area operation | single-area operation |
|------------------------|--|
| Brighter + colder (ON) | Brighter + colder / darker + warmer (TOGGLE) |
| Darker + warmer (OFF) | Brighter + colder (TOGGLE) |
| | Darker + warmer (TOGGLE) |

With dual-area operation, the device sends a telegram for switching on or off with a short signal and a telegram for dimming brighter and colder or dimming darker and warmer with a long signal.

With single-area operation, the device sends switch-on and switch-off telegrams ("UM") alternately with a short signal and "Brighter + Colder" and "Darker + Warmer" telegrams alternately with a long signal.

9.3.4 Dimming parameters

Input... -> I... - Function

| | |
|---|---|
| Debounce time (10...255 ms) | 10...255 |
| This parameter sets the debouncing time individually for the input. According to the time set here, the input signal at the input is evaluated with a delay. | |
| Colour temperature control | Checkbox (yes / no) |
| This parameter activates the variable colour temperature control and thus the Tunable White function if required. Additional parameters become visible. | |
| Communication | Individual objects Kombi object |
| When colour temperature control is activated, either the brightness or the colour temperature can be dimmed via an individual object. Alternatively, the brightness and the colour temperature can be controlled together via a combi object. | |
| Adjustment of | Brightness Colour temperature |
| For communication via individual objects, this parameter sets whether the brightness or the colour temperature is dimmed via the individual object. | |
| Brightness when closing the contact | no reaction Brighter (ON) Darker (OFF) Brighter / darker (TOGGLE) Brighter (TOGGLE) Darker (TOGGLE) |
| This parameter determines the reaction when the contact at the input is closed. If the device is to toggle on a brief signal, the corresponding switching objects of other sensors with the same function must be interlinked. | |
| This parameter is only visible if colour temperature control is deactivated or colour temperature control is active and communication is via a single object for brightness control. | |

| | |
|--|---|
| Colour temperature when closing the contact | no reaction Colder (ON) Warmer (OFF) Colder / warmer (TOGGLE) Colder (TOGGLE) Warmer (TOGGLE) |
| <p>This parameter determines the reaction when the contact at the input is closed. If the device is to toggle on a brief signal, the corresponding switching objects of other sensors with the same function must be interlinked.</p> <p>This parameter is only visible if colour temperature control is active and communication is via a single object for controlling the colour temperature.</p> | |
| Brightness + colour temperature when closing the contact | no reaction Brighter + colder (ON) Darker + warmer (OFF) Brighter + colder / darker + warmer (TOGGLE) Brighter + colder (TOGGLE) Darker + warmer (TOGGLE) |
| <p>This parameter determines the reaction when the contact at the input is closed. If the device is to toggle on a brief signal, the corresponding switching objects of other sensors with the same function must be interlinked.</p> <p>This parameter is only visible if colour temperature control is active and communication is via a combi object for controlling brightness and colour temperature.</p> | |
| After bus voltage return | no reaction Send ON telegram Send OFF telegram |
| <p>At this point, the behaviour of the input after a device reset (bus voltage return, ETS programming operation) is defined. If a delay after bus voltage return is set for the inputs, the device will not carry out the reaction specified at this point until the delay has expired.</p> <p>no reaction: The device does not send a telegram for initialisation.</p> <p>Send ON telegram: The device sends an ON command for the input via the communication object "Switch".</p> <p>Send OFF telegram: The device sends an OFF command for the input via the communication object "Switch".</p> | |
| Time between switching and dimming Seconds (0...50) | 0 ... 50 s |
| <p>This parameter determines how long a signal must last with a closed contact until a long signal is identified and a dimming telegram is triggered.</p> <p>Setting the seconds of time between switching and dimming.</p> | |

| | |
|---|-------------------------------|
| Milliseconds (100...990) | 100 ... 400 ... 990 ms |
| Setting the milliseconds of time between switching and dimming. | |

| | |
|---|---------------------|
| Advanced parameters | Checkbox (yes / no) |
| At this point, the extended parameters of the dimming function can be activated and thus made visible, if required. | |

| | |
|------------------------|---|
| Increase brightness by | 1.5 % 3 % 6 % 12.5 % 25 % 50 % 100 % |
|------------------------|---|

This parameter sets the relative dimming level when the brightness is increased. On each new signal, the brightness is changed at maximum by the configured step width.
It is recommended that the device repeats the dimming telegrams automatically, particularly with a small dimming level (see "Telegram repetition").

| | |
|----------------------|---|
| Reduce brightness by | 1.5 % 3 % 6 % 12.5 % 25 % 50 % 100 % |
|----------------------|---|

This parameter sets the relative dimming level when the brightness is reduced. On each new signal, the brightness is changed at maximum by the configured step width.
It is recommended that the device repeats the dimming telegrams automatically, particularly with a small dimming level (see "Telegram repetition").

| | |
|---|---|
| Dimming colder by | 1.5 % 3 % 6 % 12.5 % 25 % 50 % 100 % |
| <p>This parameter sets the relative dimming step for cold dimming. On each new signal, the brightness is changed at maximum by the configured step width. It is recommended that the device repeats the dimming telegrams automatically, particularly with a small dimming level (see "Telegram repetition").</p> | |
| Dimming warmer by | 1.5 % 3 % 6 % 12.5 % 25 % 50 % 100 % |
| <p>This parameter sets the relative dimming step for dimming warmer. On each new signal, the brightness is changed at maximum by the configured step width. It is recommended that the device repeats the dimming telegrams automatically, particularly with a small dimming level (see "Telegram repetition").</p> | |
| Stop telegram | Checkbox (yes / no) |
| <p>If this parameter is activated, the device sends a telegram to stop the dimming process when the contact is opened.</p> | |
| Telegram repetition | Checkbox (yes / no) |
| <p>At this point, the telegram repetition can be activated during dimming. With telegram repetition activated, the device cyclically sends relative dimming telegrams (in the parameterised step width) to the KNX if the button is pressed long.</p> | |
| Time between two telegrams | 200 ms 300 ms 400 ms 500 ms 750 ms 1 s 2 s |
| <p>This parameter defines the interval at which the dimming telegrams are automatically repeated in the telegram repetition mode. This parameter is only visible when telegram repetition is activated.</p> | |

9.3.5 Dimming objects

| Object no. | Function | Name | Type | DPT | Flag |
|---------------|-----------|-------------------|-------|-------|---------------|
| 486, 492, 498 | Switching | Input... - Output | 1-bit | 1,001 | C, R, -, T, A |

1-bit object for transmission of switching telegrams (ON, OFF).

| Object no. | Function | Name | Type | DPT | Flag |
|---------------|--------------------|-------------------|-------|-------|---------------|
| 487, 493, 499 | Dimming brightness | Input... - Output | 4-bit | 3,007 | C, R, -, T, A |

4-bit individual object for sending relative dimming telegrams to adjust the brightness.

| Object no. | Function | Name | Type | DPT | Flag |
|---------------|----------------------------|-------------------|-------|-------|---------------|
| 489, 495, 501 | Dimming colour temperature | Input... - Output | 4-bit | 3,007 | C, R, -, T, A |

4-bit object for sending relative dimming telegrams to adjust the colour temperature.

| Object no. | Function | Name | Type | DPT | Flag |
|---------------|---|-------------------|---------|---------|---------------|
| 487, 493, 499 | Dimming brightness + colour temperature | Input... - Output | 3 bytes | 250,600 | C, R, -, T, A |

3-byte combination object for sending dimming telegrams for adjusting the brightness and the colour temperature in combination.

| Object no. | Function | Name | Type | DPT | Flag |
|---------------|--------------------|------------------|-------|-------|---------------|
| 488, 494, 500 | Switching feedback | Input... - Input | 1-bit | 1,001 | C, -, W, -, U |

1-bit object for receiving feedback telegrams (ON, OFF) from other control points.

9.4 Venetian blind

For each input whose function is set to "Venetian blind", the 1-bit objects "Short time operation" and "Long time operation" are available. The function distinguishes between dual-area operation (UP, DOWN) and single-area operation (TOGGLE). The "Command when closing the contact" parameter defines the single- or dual-area dimming principle.

| dual-area operation | single-area operation |
|---------------------|-----------------------|
| UP | TOGGLE |
| DOWN | |

With dual-area operation, the device sends an UP or DOWN telegram when the contact closes according to the configuration. With single-area operation, the device switches the direction of travel for short- and long-term operation (UM) every time the contact closes on a long signal.

Feedback

If the actuator can be controlled from several control points, a faultless single-area operation requires that the long time objects of the control elements are interlinked. The device would otherwise not be able to detect that the actuator has been addressed from another sensor, in which case it would have to be actuated twice during the next use in order to produce the desired reaction.

Behaviour after bus voltage return

After a device reset (bus voltage return or ETS programming operation), the communication object "Long time operation" of an input can be initialised. For this, the "On bus voltage return" parameter should be configured to the required reaction. With the settings "DOWN" or "UP", telegrams are actively sent out on the KNX according to this specification.

- i** If a delay is set for the inputs after bus voltage return, the device only transmits the telegrams when the delay has elapsed.

Operation concepts

For the control of Venetian blind, shutter, awning or similar drives, the device supports four operating concepts, for which the telegrams are transmitted in different time sequences. The device can therefore be used to operate a wide variety of drive configurations.

Operation concept "short – long – short"

In the operation concept "short – long – short", the device shows the following behaviour:

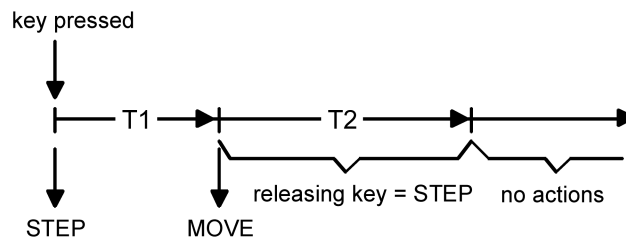

Image 14: Operation concept "short – long – short"

- Immediately when the contact closes, the device sends a short time telegram. Pressing the button stops a running drive and starts time T1 ("time between short time and long time command"). If the contact at the input is opened again within T1, no further telegram is sent. This short time serves the purpose of stopping a continuous movement. The "time between short and long time command" in the device should be selected shorter than the short-time operation of the actuator to prevent a jerky movement of the blind.
- If the signal at the input is longer than T1, the device transmits a long time telegram after the end of T1 for starting up the drive and time T2 ("slat adjusting time") is started.
- If the contact at the input is opened within the slat adjusting time, the device sends out another short time telegram. This function is used for adjusting the slats of a blind. The function permits stopping the slats in any position during their rotation. The "slat adjusting time" should be chosen as required by the drive for a complete rotation of the slats. If the "slat adjusting time" is selected longer than the complete running time of the drive, a push button function is possible as well. In this case, the drive only moves as long as the contact at the input is closed.
- If the signal at the input lasts longer than T2, the device does not send another telegram. The drive remains on until the end position is reached.

Operation concept "long – short":

In the operation concept "long – short", the device shows the following behaviour:

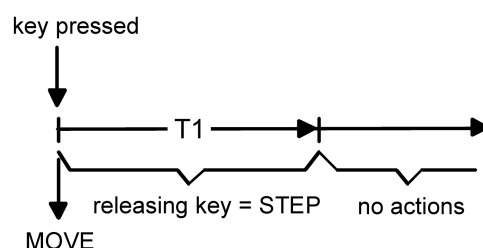

Image 15: Operation concept "long – short"

- Immediately when the contact closes, the device sends a long time telegram. The drive begins to move and time T1 ("slat adjusting time") is started.
- If the contact at the input is opened again within the slat adjusting time, the device sends out a short-time telegram. This function is used for adjusting the slats of a blind. The function permits stopping the slats in any position during their rotation. The "slat adjusting time" should be chosen as required by the drive for a com-

plete rotation of the slats. If the "slat adjusting time" is selected longer than the complete running time of the drive, a push button function is possible as well. In this case, the drive only moves as long as the contact at the input is closed.

- If the signal at the input lasts longer than T1, the device does not send another telegram. The drive remains on until the end position is reached.

Operation concept "short – long"

In the operation concept "short – long", the device shows the following behaviour:

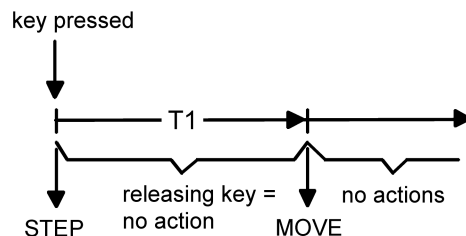

Image 16: Operation concept "short – long"

- Immediately when the contact closes, the device sends a short time telegram. Pressing the button stops a running drive and starts time T1 ("time between short time and long time command"). If the contact at the input is opened again within T1, the device does not send another telegram. This short time serves the purpose of stopping a continuous movement. The "time between short and long time command" in the device should be selected shorter than the short-time operation of the actuator to prevent a jerky movement of the blind.
- If the signal at the input lasts longer than T1, the device sends out a long term telegram to drive the actuator after T1 has elapsed.
- When the contact is opened, the device does not send another telegram. The drive remains on until the end position is reached.

Operation concept "long – short or short"

In the operation concept "long – short or short", the device shows the following behaviour:

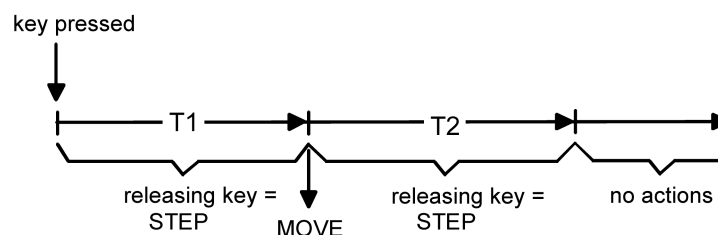

Image 17: Operation concept "long – short or short"

- Immediately on closing the contact, the device starts time T1 ("time between short time and long time command") and waits. If the contact at the input is opened again before T1 expires, the device sends a short time telegram. This telegram can be used to stop a running drive. A stationary drive rotates the slats by one level.

- If the signal at the input lasts longer than T1, the device sends a long term telegram and starts time T2 ("slat adjusting time").
- If the contact at the input is opened within T2, the device sends out another short-time telegram. This function is used for adjusting the slats of a blind. The function permits stopping the slats in any position during their rotation. The "slat adjusting time" should be chosen as required by the drive for a complete rotation of the slats. If the "slat adjusting time" is selected longer than the complete running time of the drive, a push button function is possible as well. In this case, the drive only moves as long as the contact at the input is closed.
- If the contact at the input remains closed longer than T2, the device does not send another telegram. The drive remains on until the end position is reached.

9.4.1 Shutter/blind parameters

Input... -> I... - Function

| | |
|--|---|
| Debounce time (10...255 ms) | 10...255 |
| This parameter sets the debouncing time individually for the input. According to the time set here, the input signal at the input is evaluated with a delay. | |
| When closing the contact | UP DOWN TOGGLE |
| This parameter determines the direction of movement of the drive when closing the contact. If the setting is "TOGGLE", the direction is changed after each long time command. If several devices are to control the same drive, the long time objects of the devices must be interlinked to ensure that the running direction can be changed correctly. | |
| After bus voltage return | no reaction UP DOWN |
| <p>At this point, the behaviour of the input after a device reset (bus voltage return, ETS programming operation) is defined. If a delay after bus voltage return is set for the inputs, the device will not carry out the reaction specified at this point until the delay has expired.</p> <p>no reaction: The device does not send a telegram for initialisation.</p> <p>DOWN: The device sends a shutdown command for the input via the communication object "Long term operation".</p> <p>UP: The device sends a open command for the input via the communication object "Long term operation".</p> | |
| Operation concept | short – long – short long – short short – long long – short or short |
| <p>For the control of Venetian blind, shutter, awning or similar drives, the device supports four operating concepts, for which the telegrams are transmitted in different time sequences. The device can therefore be used to operate a wide variety of drive configurations.</p> <p>At this point, the operating concepts can be selected.</p> | |

| | |
|--|-----------------|
| Time between short-time and long-time command Minutes (0...5) | 0...5 |
| <p>The time after which long term operation is evaluated when the contact closes is set here.</p> <p>Setting the minutes of time between short and long command.</p> | |
| Seconds (0...59) | 0...59 |
| <p>Setting the seconds of time between short and long command.</p> | |
| Milliseconds (100...990) | 100...400...990 |
| <p>Setting the milliseconds of time between short and long command.</p> <p>The parameters "Time between short and long command" are not visible with "Operating concept = Long - Short".</p> | |
| Slat adjusting time Minutes (0...5) | 0...5 |
| <p>Here you set the time during which an emitted short time telegram can be terminated by opening the contact. This function serves to adjust the slats of a blind.</p> <p>Setting the minutes of the slat adjusting time.</p> | |
| Seconds (0...59) | 0...59 |
| <p>Setting the seconds of the slat adjusting time.</p> | |
| Milliseconds (0...990) | 0...500...990 |
| <p>Setting the milliseconds of the slat adjusting time.</p> <p>The "Slat adjusting time" parameters are not visible with "Operating concept = Short - Long".</p> | |

9.4.2 Shutter/blinds objects

| Object no. | Function | Name | Type | DPT | Flag |
|---------------|----------------------|-------------------|-------|-------|---------------|
| 516, 519, 522 | Short time operation | Input... - Output | 1-bit | 1,007 | C, R, -, T, A |

1-bit object for the transmission of telegrams with which a Venetian blind or shutter drive motor can be stopped or with which the blind slats can be adjusted by short time operation.

| Object no. | Function | Name | Type | DPT | Flag |
|---------------|---------------------|-------------------|-------|-------|-----------------|
| 517, 520, 523 | Long-time operation | Input... - Output | 1-bit | 1,008 | C, (R), W, T, A |

1-bit object for the transmission of telegrams with which a Venetian blind or shutter drive motor can be can be moved upwards or downwards.

9.5 Value transmitter

With the "Value transmitter" function, the device sends parameterised values to the KNX when the contact at the input closes. The value transmitter distinguishes between different value ranges depending on the data format. Depending on the application, the parameters "Function" and "Value range" determine which value range the value transmitter uses.

| Function | Value range | Range end below | Range end top |
|--------------------------|---------------------------------------|-----------------|-----------------|
| 1-byte value transmitter | 0...255 | 0 | 255 |
| 1-byte value transmitter | 0...100% | 0% | 100% |
| 1-byte value transmitter | -128...127 | -128 | 127 |
| 1-byte value transmitter | 0...255% | 0% | 255% |
| 1-byte value transmitter | 0...360° | 0° | 360° |
| 2-byte value transmitter | 0...65535 | 0 | 65535 |
| 2-byte value transmitter | -32768...32767 | -32768 | 32767 |
| 2-byte value transmitter | Temperature value | 0 °C | 40 °C |
| 2-byte value transmitter | brightness value | 0 lux | 1500 lux |
| 2-byte value transmitter | Colour temperature value | 1000 K | 10000 K |
| 3-byte value transmitter | RGB/HSV with colour wheel sequence | #000000 | #FFFFFF |
| 3-byte value transmitter | RGB/HSV with brightness adjustment | #000000 | #FFFFFF |
| 6-byte value transmitter | Colour value RGBW/HSVW | #000000 + 0 | #FFFFFF + 255 |
| 6-byte value transmitter | Colour temperature value + brightness | 1000 K 0 % | 10000 K 100 % |

Behaviour after bus voltage return

The communication object of an input for sending the value can be initialised after a device reset (bus voltage return or ETS programming operation). For this, the "On bus voltage return" parameter should be configured to the required reaction. With the setting "Reaction as when closing the contact", the device sends out the configured values.

- i** If a delay is set for the inputs after bus voltage return, the device only transmits the telegrams when the delay has elapsed.

Value adjustment

If the value adjustment is activated in the ETS, the contact at the input for adjusting the value must remain closed for longer than the parameterised time period. The value adjustment function continues until the contact is opened again.

- With the 1 byte and 2 byte value transmitter functions the value is adjusted across the entire number range.
- With the 3 byte value transmitter function in the function RGB/HSV with colour wheel adjustment, the colour hue (H) is adjusted in the range from 0 to 360°.
- With the 3 byte value transmitter function in the RGB / HSV function with brightness adjustment, the brightness value (V) is adjusted in the range from 0 to 100%.

With the activation of the "Value adjustment" parameter, further parameters become visible in the ETS, whereby the value adjustment can be configured.

- i** For the value transmitter 1 byte with the value range "0...100%", the step width of the value adjustment is also specified in "%". If the starting value of the communication object is used, it may happen in this case during value adjustment that the value last received via the object must be rounded and adapted before a new value can be calculated on the basis of the step width and transmitted. Due to the computation procedure used, the new calculation of the value may be slightly inaccurate.

- i** The value adjustment is not available with the "6 byte" mode of operation.

Example 1: Value adjustment without overflow

- Mode of operation and value range = 1 byte (0...255)
- Value = 227
- Step width = 5
- Starting value on value adjustment = same as configured value
- Direction of value adjustment = toggling (alternating)
- Time between two telegrams = 0.5 s

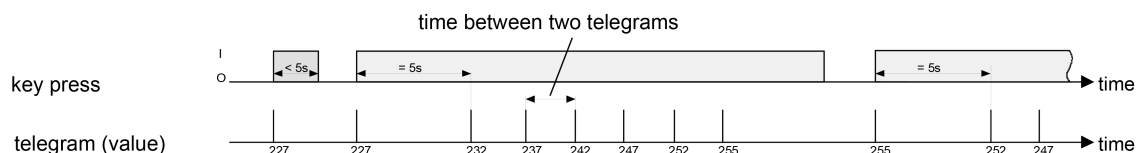

Image 18: Example of value adjustment without value range overflow

Example 2: Value adjustment with overflow

- Mode of operation and value range = Value transmitter 1 byte (0...255)
- Value = 227

Example 2: Value adjustment with overflow

- Step width = 5
- Starting value on value adjustment = same as configured value
- Direction of value adjustment = toggling (alternating)
- Time between two telegrams = 0.5 s

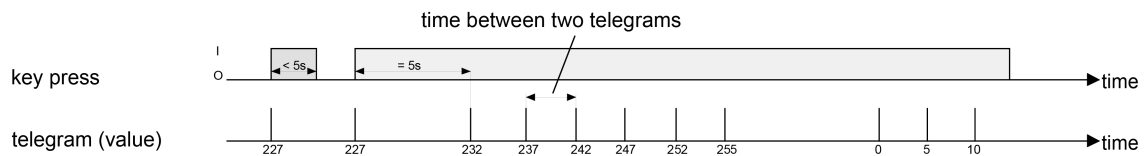

Image 19: Example of value adjustment with value range overflow

- i** The newly adjusted values are stored in non-volatile memory. The stored values are thereby replaced by the preset values programmed in the ETS when a reset of the device occurs (bus voltage failure or ETS programming).

9.5.1 1-byte value transmitter

The 1-byte value transmitter is available in the following four variants:

- 0 ... 255
- 0 ... 100%
- -128 ... 127
- 0 ... 255%
- 0 ... 360°

For each input, an object is available in the ETS for sending out the parameterised value. When the contact closes, the parameterised value is sent out on the KNX.

9.5.2 2-byte value transmitter

The 2-byte value transmitter is available in the following five variants:

- 0 ... 65535
- -32768 ... 32767
- Temperature value (0 ... 40 °C)
- Brightness value (0, 50, ..., 1500 lux)
- Colour temperature value (1000, 1100, ..., 10000)

For each input, an object is available in the ETS for sending out the parameterised value. When the contact closes, the parameterised value is sent out on the KNX.

9.5.3 3-byte value transmitter

The 3-byte value transmitter is available in the following variant:

- RGB/HSV with colour wheel sequence
- RGB/HSV with brightness adjustment

Objects for sending the parameterised values are available in the ETS for each input. When the contact closes, the parameterised values are sent out on the KNX. The colour circle run and the brightness adjustment are realised by a value adjustment.

Communication takes place via a 3-byte combination object according to DPT 232.600 in the RGB colour space or via three 1-byte individual objects in the HSV colour space. All four communication objects are displayed in the object overview. The object values to be sent out are parameterised via a colour picker in the ETS.

Value adjustment with colour wheel sequence

The colour wheel sequence performs a value adjustment of the colour angle (H) in the range from 0 to 360°.

- i** For the colour space "RGB", an adjustment of the colour angle (H) is converted internally in the device.

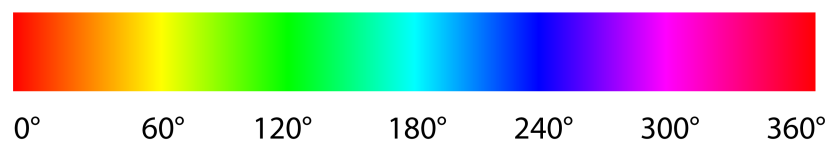

Image 20: Colour scale (Colour hue H)

The colour wheel sequence is realised according to the direction of the value adjustment and the step width via KNX telegrams. During a colour wheel sequence, the device cyclically sends new values to the KNX, whereby the colour wheel is continuously run through. The colour hue (H) changes cyclically by the parameterised step width. The saturation (S) and the brightness value (V) remain unaffected by a colour pass. Depending on the start position at the beginning of the adjustment, the values R, G or B change cyclically.

Using the colour picker of the ETS, the colour wheel sequence can be traced by adjusting the slider of the H value from 0° to 360°.

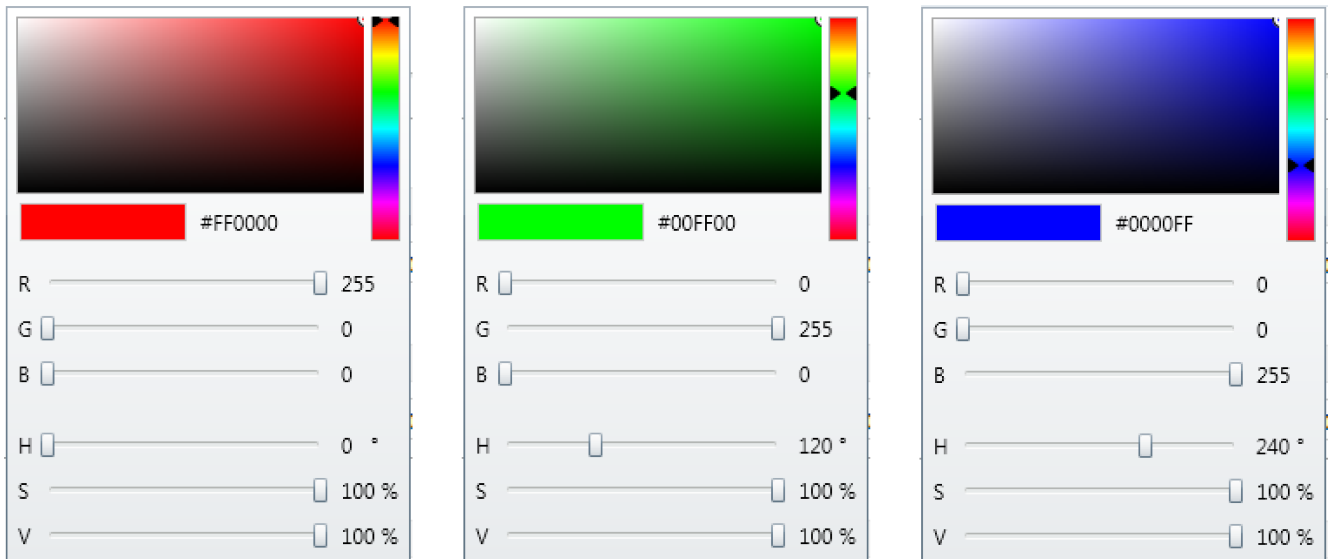

Image 21: Examples of colour adjustment using the ETS colour picker

Examples of HSV-RGB conversion:

| Example | HSV - Values | RGB - Values | Colour |
|---------|------------------|---------------|--------|
| 1 | 0°, 100%, 100% | 255, 0, 0 | Red |
| 2 | 120°, 100%, 100% | 0, 255, 0 | Green |
| 3 | 240°, 100%, 100% | 0, 0, 255 | Blue |
| 4 | 360°, 0%, 100% | 255, 255, 255 | White |
| 5 | 360°, 0%, 0% | 0, 0, 0 | Black |

- i** With "Saturation (S) = 0%" and "Brightness (V) = 100%", a change in the colour hue (H) has no effect on the RGB values and thus no effect on the colour.
- i** With "Saturation (S) = 0%" and "Brightness (V) = 0%", a change in the colour hue (H) has no effect on the RGB values and thus no effect on the colour.

Value adjustment with brightness adjustment

The brightness adjustment performs a value adjustment of the brightness value (V) in the range from 0 to 100%.

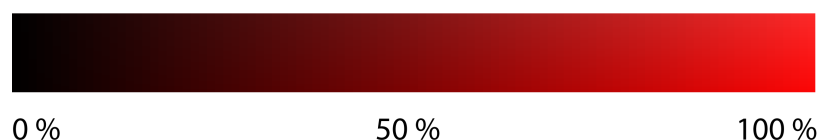

Image 22: Brightness scale (brightness value V) - example red

The brightness adjustment is realised according to the direction of the value adjustment and the step width via KNX telegrams. When adjusting the brightness, the device cyclically sends new values to the KNX, which continuously changes the brightness.

- i** The brightness adjustment ends automatically either when the brightness is increased at 100% or when the brightness is decreased at 0%. The brightness value (V) changes cyclically by the parameterised step width. The colour hue (H) and the saturation (S) remain unaffected by a brightness adjustment. Depending on the start position at the beginning of the adjustment, the values R, G or B change cyclically.

Using the colour picker of the ETS, the brightness adjustment can be reproduced by adjusting the slider of the V-value from 0% to 100%.

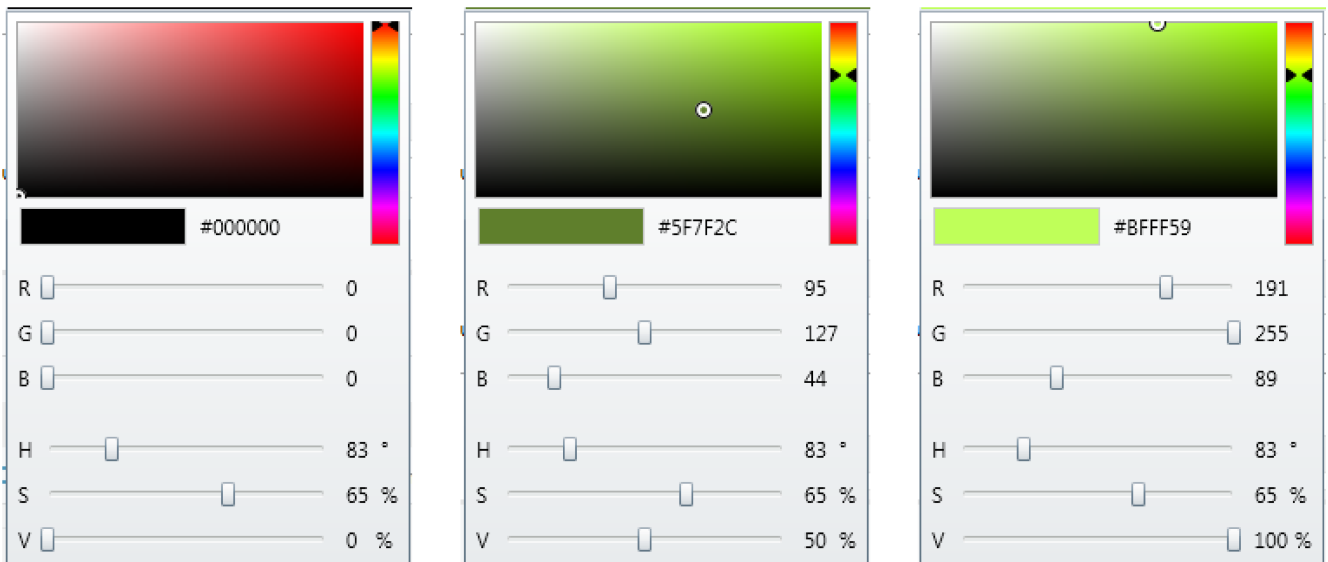

Image 23: Examples of brightness adjustment using the colour picker of the ETS

Examples of HSV-RGB conversion:

| Example | HSV - Values | RGB - Values | Colour |
|---------|----------------|--------------|-------------|
| 1 | 83°, 65%, 0% | 0, 0, 0 | Black |
| 2 | 83°, 65%, 50% | 95, 127, 44 | Dark green |
| 3 | 83°, 65%, 100% | 191, 255, 89 | Light green |

- i** With "Brightness value (V) = 0%", a change in the colour angle (H) or saturation (S) has no effect on the RGB values and thus no effect on the colour.

9.5.4 6-byte value transmitter

The 6-byte value transmitter is available in the following two variants:

- Colour value RGBW/HSVW
- Colour temperature value + brightness

Objects for sending the parameterised values are available in the ETS for each input. When the contact closes, the parameterised values are sent out on the KNX.

With the value range "Colour value RGBW/HSVW", the colour space of this function can be defined in the parameters. The object values RGB or HSV to be transmitted are parameterised via a colour picker in the ETS. The object value for the white component (W) is configured via a separate slider.

Communication takes place in the RGBW colour space via a 6-byte combination object according to DPT 251.600 and in the HSVW colour space via four 1-byte individual objects. All five communication objects are displayed in the object overview.

For the value range "Colour temperature value + brightness", the object values to be transmitted for colour temperature and brightness as well as a time window are defined in the parameters. The device combines all three pieces of information together in one communication object according to DPT 249.600 and sends them to the KNX. The receiving actuator converts this information and sets the colour temperature and brightness in the parameterised time window.

9.5.5 Value transmitter parameters

Input... -> I... - Function

| | |
|--|---|
| Debounce time (10...255 ms) | 10...255 |
| This parameter sets the debouncing time individually for the input. According to the time set here, the input signal at the input is evaluated with a delay. | |
| Function | No function 1 bytes 2 bytes 3 bytes 6 bytes |
| At this point, the functionality of the encoder is defined. | |
| Value range | 0...255 0...100% -128...127 0...255% 0...360° |
| The 1-byte value transmitter offers these value ranges for setting. The other parameters and objects of the function are based on the setting of this parameter. | |
| Value range | 0...65535 -32768...32767 Temperature value brightness value Colour temperature value |
| The 2-byte value transmitter offers these value ranges for setting. The other parameters and objects of the function are based on the setting of this parameter. | |
| Value range | RGB/HSV with colour wheel sequence RGB/HSV with brightness adjustment |
| The 3-byte value transmitter offers these value ranges for setting. The other parameters and objects of the function are based on the setting of this parameter. | |
| Value range | Colour value RGBW/HSVW Colour temperature value + brightness |
| The 6-byte value transmitter offers these value ranges for setting. The other parameters and objects of the function are based on the setting of this parameter. | |
| Value when closing the contact (0...255) | 0...255 |
| This parameter determines the object value when closing the contact. It is only visible with "Function = 1 byte" and "Value range = 0...255". | |

| | |
|---|-----------------------------------|
| Value when closing the contact (0...100 %) | 0...100 |
| This parameter determines the object value when closing the contact. This parameter is only visible if "Function = 1-byte" and "Value range = 0...100%". | |
| Value when closing the contact (-128...127) | -128...0...127 |
| This parameter determines the object value when closing the contact. This parameter is only visible if "Function = 1-byte" and "Value range = -128...127%". | |
| Value when closing the contact (0...255%) | 0...255 |
| This parameter determines the object value when closing the contact. This parameter is only visible if "Function = 1-byte" and "Value range = 0...255%". | |
| Value when closing the contact (0...360°) | 0...360 |
| This parameter determines the object value when closing the contact. It is only visible if "Function = 0...360%". | |
| Value when closing the contact (0...65535) | 0...65535 |
| This parameter determines the object value when closing the contact. This parameter is only visible if "Function = 2-byte" and "Value range = 0...65535%". | |
| Value when closing the contact (-32768...32767) | -32768...0...32767 |
| This parameter determines the object value when closing the contact. This parameter is only visible if "Function = 2-byte" and "Value range = -32768...32767%". | |
| Temperature value when closing the contact (0...40 °C) | 0...20...40 |
| This parameter determines the object value when closing the contact. This parameter is only visible if "Function = 2-byte" and "Value range = temperature value". | |
| Brightness value when closing the contact (0, 50, ..., 1500 Lux) | 0, 50, ..., 300, ..., 1500 |
| This parameter determines the object value when closing the contact. This parameter is only visible if "Function = 2-byte" and "Value range = brightness value". | |
| Colour temperature value when closing the contact (1000, 1100, ..., 10000 K) | 1000, 1100, ..., 2700, ..., 10000 |
| This parameter determines the object value when closing the contact. This parameter is only visible if "Function = 2-byte" and "Value range = temperature value". | |

| | |
|--|--|
| Colour value when closing the contact (RGB/HSV) | #000000 ... #FFFFFF |
| This parameter determines the object values of the objects Value transmitter 3 byte and Value transmitter 6 byte, Brightness value (V), Saturation (S) and Colour hue (H) when closing the contact. It is visible for "Function = 3 byte RGB/HSV with colour wheel sequence", "Function = 3 byte RGB/HSV with brightness adjustment" and "6 byte RGBW/HSVW". | |
| White level (W) | 0...255 |
| This parameter determines the value of the White value (W) object when the contact closes. Visible only if "Function = 6 byte RGBW/HSVW". | |
| Colour temperature value (1000, 1100, ..., 10000 K) | 1000, 1100, ..., 2700, ..., 10000 |
| This parameter determines the colour temperature of the object value when the contact closes. It is only visible with "Function = 6 bytes" and "Value range = colour temperature value + brightness". | |
| brightness value (0...100%) | 0...100 |
| This parameter determines the brightness of the object value when the button is pressed. It is only visible with "Function = 6 bytes" and "Value range = colour temperature value + brightness". | |
| Time frame (0...100 minutes) | 0...100 |
| This parameter determines the time period in which the actuator adjusts the colour temperature and brightness after the contact is closed. It is only visible with "Function = 6 bytes" and "Value range = colour temperature value + brightness". Setting the minutes of the time window. | |
| (0...59 seconds) | 0...1...59 |
| Setting the seconds of the time window. | |
| (0...900 milliseconds) | 0...900 |
| Setting the milliseconds of the time window. | |
| After bus voltage return | no reaction Reaction as when closing the contact |
| At this point, the behaviour of the input after a device reset (bus voltage return, ETS programming operation) is defined. If a delay after bus voltage return is set for the inputs, the device will not carry out the reaction specified at this point until the delay has expired. no reaction: The device does not send a telegram for initialisation. Reaction as when closing the contact: When closing the contact, the device sends out the configured values. | |

| | |
|---|---|
| Value adjustment | Checkbox (yes / no) |
| <p>This parameter optionally enables the value adjustment.</p> <p>i The value adjustment is not available with the "6 byte" mode of operation.</p> | |
| Starting value in case of value adjustment | <p>same as configured value</p> <p>Same as value after last adjustment</p> <p>Same as value from communication object</p> |
| <p>Value adjustment can begin with different starting values. This parameter is visible only if the value adjustment is enabled! The selection is only available for the 1-byte and 2-byte modes.</p> <p>Same as parameterised value: After each long press, the device always starts with the value configured in the ETS.</p> <p>Same as value after last adjustment: After a long press, the device starts with the value transmitted by itself or by another device with this group address as the last value.</p> <p>Same as value from communication object: After a long press, the device starts with the value transmitted by itself or by another device with this group address as the last value.</p> | |
| Starting value in case of value adjustment | <p>same as configured value</p> <p>Same as value after last adjustment</p> <p>same as value from feedback object (1-byte colour hue/H-value)</p> <p>as value from feedback object (3-byte RGB)</p> |
| <p>Value adjustment can begin with different starting values. This parameter is visible only if the value adjustment is enabled! The selection is only available with the 3-byte RGB/HSV mode of operation with colour wheel scrolling.</p> <p>Same as parameterised value: After each long press, the device always starts with the value configured in the ETS.</p> <p>Same as value after last adjustment: After a long press, the device starts with the value transmitted by itself or by another device with this group address as the last value.</p> <p>Same as value on feedback object (1-byte colour hue/H-value): After a long press, the device starts with the value transmitted by itself or by another device with this group address as the last value.</p> <p>Same as value from feedback object (3-byte RGB): After a long press, the device starts with the value transmitted by itself or by another device with this group address as the last value.</p> | |

| | |
|---|--|
| Starting value in case of value adjustment | same as configured value Same as value after last adjustment same as value on feedback object (1-byte brightness/V-value) as value from feedback object (3-byte RGB) |
| <p>Value adjustment can begin with different starting values. This parameter is visible only if the value adjustment is enabled! The selection is only available with the 3-byte RGB/HSV function with brightness adjustment.</p> <p>Same as parameterised value: After each long press, the device always starts with the value configured in the ETS.</p> <p>Same as value after last adjustment: After a long press, the device starts with the value transmitted by itself or by another device with this group address as the last value.</p> <p>Same as value on feedback object (1-byte brightness/V-value): After a long press, the device starts with the value transmitted by itself or by another device with this group address as the last value.</p> <p>Same as value from feedback object (3-byte RGB): After a long press, the device starts with the value transmitted by itself or by another device with this group address as the last value.</p> | |
| Direction of value adjustment | upwards downwards toggleing (alternating) |
| <p>The device can either always adjust the values in the same direction when there is a long signal at the input, or it stores the direction of the last adjustment and reverses it when there is a new signal at the input. This parameter is visible only if the value adjustment is enabled! The selection is only available for the 1-byte and 2-byte modes.</p> | |
| Direction of the colour sequence | Colour sequence in clockwise direction (red -> green -> blue -> red -> ...) Colour sequence in anti-clockwise direction (red -> blue -> green -> red -> ...) Toggleing colour sequence (alternating whenever a button is pressed for a longer period of time) |
| <p>The device can either always adjust the values in the same direction when there is a long signal at the input, or it stores the direction of the last adjustment and reverses it when there is a new signal at the input. This parameter is visible only if the value adjustment is enabled! The selection is only available with the 3-byte RGB/HSV mode of operation with colour wheel scrolling.</p> | |

| | |
|---|---|
| Direction of the brightness adjustment | brighter darker toggling (alternating) |
| <p>The device can either always adjust the values in the same direction when there is a long signal at the input, or it stores the direction of the last adjustment and reverses it when there is a new signal at the input. This parameter is visible only if the value adjustment is enabled! The selection is only available with the 3-byte RGB/HSV function with brightness adjustment.</p> | |
| Step width | 1...15 |
| <p>In a value adjustment, the device determines the new telegram value from the previous value and the preset step width. If the lower limit of the adjustment range is not reached or the upper limit is exceeded, the device automatically adjusts the step size for the last step.</p> <p>This parameter is only visible when value adjustment is enabled and is only available with the following functions: 1 byte (0...255), 1 byte (0...100%), 1 byte (-128...127), 1 byte (0...255%) and 1 byte (0...360°).</p> | |
| Step width | 1, 2, 5, 10, 20, 50, 75, 100, 200, 500, 750, 1000 |
| <p>In a value adjustment, the device determines the new telegram value from the previous value and the preset step width. If the lower limit of the adjustment range is not reached or the upper limit is exceeded, the device automatically adjusts the step size for the last step.</p> <p>This parameter is only visible when value adjustment is enabled and is only available with the following functions: 2 bytes (0...65535) and 2 bytes (-32768...32767).</p> | |
| Step width | 1 |
| <p>With the 2-byte temperature value transmitter, the step size of the value adjustment is always set to "1°C" and cannot be changed.</p> <p>This parameter is only visible with enabled value adjustment and only available with the following mode of operation: 2-byte temperature value.</p> | |
| Step width (1...1000 K) | 1, 10, 20, ..., 500, ..., 1000 |
| <p>In a value adjustment, the device determines the new telegram value from the previous value and the preset step width. If the lower limit of the adjustment range is not reached or the upper limit is exceeded, the device automatically adjusts the step size for the last step.</p> <p>This parameter is only visible with enabled value adjustment and only available with the following function: 2-byte colour temperature value.</p> | |

| | |
|--|---|
| Step width | 50 |
| <p>With the 2-byte brightness value transmitter, the step size of the value adjustment is always set to "50 lux" and cannot be changed.</p> <p>This parameter is only visible with enabled value adjustment and only available with the following function: 2-byte brightness value.</p> | |
| Step width | 1°, 2°, 4°, 5°, 10°, 20°, 25°, 30°, 50°, 60° |
| <p>In a value adjustment, the device determines the new telegram value from the previous value and the preset step width. If the lower limit of the adjustment range is not reached or the upper limit is exceeded, the device automatically adjusts the step size for the last step.</p> <p>This parameter is only visible when the value adjustment is enabled and is only available with the following modes of operation: 3-byte RGB/HSV with colour circle run-through.</p> | |
| Step width | 1...15 |
| <p>In a value adjustment, the device determines the new telegram value from the previous value and the preset step width. If the lower limit of the adjustment range is not reached or the upper limit is exceeded, the device automatically adjusts the step size for the last step.</p> <p>This parameter is only visible with enabled value adjustment and only available with the following function: 3-byte RGB/HSV with brightness adjustment.</p> | |
| Time period until the start of value adjustment | 0.5 s 1 s 2 s 3 s 5 s |
| <p>This parameter determines the time from which the device starts the value adjustment after the contact is closed.</p> <p>This parameter is visible only if the value adjustment is enabled!</p> | |
| Time between two telegrams | 0.5 s 1 s 2 s 3 s |
| <p>This parameter defines the interval at which the device transmits new telegrams during a value adjustment.</p> <p>This parameter is visible only if the value adjustment is enabled!</p> | |

| Value adjustment with overflow | Checkbox (yes / no) |
|--|---------------------|
| <p>If the value adjustment is to take place without overflow (parameter deactivated) and the device reaches the lower limit of the adjustment range or the upper limit during the value adjustment, it ends the value adjustment automatically.</p> <p>If the value adjustment is to be made with overflow (parameter activated) and the device reaches the lower or upper range limit, it sends the value of this range limit and then inserts a pause whose duration corresponds to two steps. Thereafter, the device transmits a telegram with the value of the other range limit and continues the value adjustment in the same direction.</p> | |

9.5.6 Value transmitter objects

| Object no. | Function | Name | Type | DPT | Flag |
|---------------|------------------------------|-------------------|---------|-------|-----------------|
| 531, 543, 555 | Value transmitter 0...255 | Input... - Output | 1 bytes | 5,010 | C, (R), W, T, A |

1-byte object for transmitting values from 0 to 255.

- i** These objects are only visible when:
- "Function = 1 bytes" and
 - "Value range: 0...255"

| Object no. | Function | Name | Type | DPT | Flag |
|---------------|--------------------------------|-------------------|---------|-------|-----------------|
| 531, 543, 555 | Value transmitter 0...100 % | Input... - Output | 1 bytes | 5,001 | C, (R), W, T, A |

1-byte object for transmitting values from 0 to 100%.

- i** These objects are only visible when:
- "Function = 1 bytes" and
 - "Value range: 0...100%"

| Object no. | Function | Name | Type | DPT | Flag |
|---------------|---------------------------------|-------------------|---------|-------|-----------------|
| 531, 543, 555 | Value transmitter -128...127 | Input... - Output | 1 bytes | 6,010 | C, (R), W, T, A |

1-byte object for transmitting values from -128 to 127.

- i** These objects are only visible when:
- "Function = 1 bytes" and
 - "Value range: -128...127"

| Object no. | Function | Name | Type | DPT | Flag |
|---------------|--------------------------------|-------------------|---------|-------|-----------------|
| 531, 543, 555 | Value transmitter 0...255 % | Input... - Output | 1 bytes | 5,004 | C, (R), W, T, A |

1-byte object for transmitting values from 0 to 255%.

- i** These objects are only visible when:
- "Function = 1 bytes" and
 - "Value range: 0...255%"

| Object no. | Function | Name | Type | DPT | Flag |
|---------------|-------------------------------|-------------------|---------|-------|-----------------|
| 531, 543, 555 | Value transmitter 0...360° | Input... - Output | 1 bytes | 5,003 | C, (R), W, T, A |

1-byte object for transmitting values from 0 to 360°.

- i** These objects are only visible when:
- "Function = 1 bytes" and
 - "Value range: 0...360°"

| Object no. | Function | Name | Type | DPT | Flag |
|---------------|--------------------------------|-------------------|---------|-------|-----------------|
| 531, 543, 555 | Value transmitter 0...65535 | Input... - Output | 2 bytes | 7,001 | C, (R), W, T, A |

2-byte object for transmitting values from 0 to 65535.

- i** These objects are only visible when:
- "Function = 2 bytes" and
 - "Value range: 0...65535"

| Object no. | Function | Name | Type | DPT | Flag |
|---------------|-------------------------------------|-------------------|---------|-------|-----------------|
| 531, 543, 555 | Value transmitter -32768...32767 | Input... - Output | 2 bytes | 8,001 | C, (R), W, T, A |

2-byte object for transmitting values from -32768 to 32767.

- i** These objects are only visible when:
- "Function = 2 bytes" and
 - "Value range: -32768...32767"

| Object no. | Function | Name | Type | DPT | Flag |
|---------------|-------------------------------|-------------------|---------|-------|-----------------|
| 531, 543, 555 | Temperature value transmitter | Input... - Output | 2 bytes | 9,001 | C, (R), W, T, A |

2-byte object for transmitting temperature values from 0 to 40 °C.

- i** These objects are only visible when:
- "Function = 2 bytes" and
 - "Value range = temperature value"

| Object no. | Function | Name | Type | DPT | Flag |
|---------------|------------------------------|-------------------|---------|-------|-----------------|
| 531, 543, 555 | Brightness value transmitter | Input... - Output | 2 bytes | 9,004 | C, (R), W, T, A |

2-byte object for transmitting brightness values from 0 to 1500 Lux.

- i** These objects are only visible when:
- "Function = 2 bytes" and
 - "Value range = brightness value"

| Object no. | Function | Name | Type | DPT | Flag |
|---------------|--------------------------------------|-------------------|---------|-------|-----------------|
| 531, 543, 555 | Colour temperature value transmitter | Input... - Output | 2 bytes | 7,600 | C, (R), W, T, A |

2-byte object for transmitting colour temperature values from 1000 to 10000 Kelvin.

- i** These objects are only visible when:
- "Function = 2 bytes" and
 - "Value range = colour temperature value"

| Object no. | Function | Name | Type | DPT | Flag |
|--|---|-------------------|---------|---------|---------------|
| 531, 543, 555 | Value transmitter 3 bytes (colour wheel sequence) | Input... - Output | 3 bytes | 232,600 | C, R, -, T, A |
| 3-byte object for transmitting 3-byte colour information. | | | | | |
| <p>i These objects are only visible if function: 3-byte RGB/HSV with colour wheel sequence.</p> | | | | | |

| Object no. | Function | Name | Type | DPT | Flag |
|--|--|-------------------|---------|---------|---------------|
| 531, 543, 555 | Value transmitter 3-byte (brightness adjustment) | Input... - Output | 3 bytes | 232,600 | C, R, -, T, A |
| 3-byte object for transmitting 3-byte colour information. | | | | | |
| <p>i These objects are only visible if function: 3-byte RGB/HSV with brightness adjustment.</p> | | | | | |

| Object no. | Function | Name | Type | DPT | Flag |
|---|--------------------------|-------------------|---------|---------|---------------|
| 531, 543, 555 | 6-byte value transmitter | Input... - Output | 6 bytes | 251,600 | C, R, -, T, A |
| 6-byte object for transmitting 6-byte colour information. | | | | | |
| <p>i These objects are only visible if function: 6-byte RGBW/HSVW.</p> | | | | | |

| Object no. | Function | Name | Type | DPT | Flag |
|---|----------------|-------------------|---------|-------|---------------|
| 532, 544, 556 | Colour hue (H) | Input... - Output | 1 bytes | 5,003 | C, R, -, T, A |
| 1-byte object for transmitting the colour hue. | | | | | |
| <p>i These objects are only visible if functions:</p> <ul style="list-style-type: none"> - 3-byte RGB/HSV with colour wheel sequence - 3-byte RGB/HSV with brightness adjustment - 6-byte RGBW/HSVW | | | | | |

| Object no. | Function | Name | Type | DPT | Flag |
|---|----------------|-------------------|---------|-------|---------------|
| 533, 545, 557 | Saturation (S) | Input... - Output | 1 bytes | 5,001 | C, R, -, T, A |
| 1-byte object for transmitting the saturation. | | | | | |
| <p>i These objects are only visible if functions:</p> <ul style="list-style-type: none"> - 3-byte RGB/HSV with colour wheel sequence - 3-byte RGB/HSV with brightness adjustment - 6-byte RGBW/HSVW | | | | | |

| Object no. | Function | Name | Type | DPT | Flag |
|---------------|----------------|-------------------|---------|-------|---------------|
| 534, 546, 558 | Brightness (V) | Input... - Output | 1 bytes | 5,001 | C, R, -, T, A |

1-byte object for transmitting the brightness value.

- i** These objects are only visible if functions:
- 3-byte RGB/HSV with colour wheel sequence
 - 3-byte RGB/HSV with brightness adjustment
 - 6-byte RGBW/HSVW

| Object no. | Function | Name | Type | DPT | Flag |
|---------------|-----------------|-------------------|---------|-------|---------------|
| 535, 547, 559 | White level (W) | Input... - Output | 1 bytes | 5,001 | C, R, -, T, A |

1-byte object for transmitting the white level.

- i** These objects are only visible if function: 6-byte RGBW/HSVW.

| Object no. | Function | Name | Type | DPT | Flag |
|---------------|-------------------------------|------------------|---------|-------|-----------------|
| 537, 549, 561 | Feedback brightness value (V) | Input... - Input | 1 bytes | 5,001 | C, (R), W, -, A |

1-byte object for receiving the brightness value.

- i** These objects are only visible with the following configuration:
- "Function" parameter = 3-byte RGB/HSV with brightness adjustment
 - "Starting value of value adjustment" parameter = same as value from feedback object (1-byte brightness/V-value)

| Object no. | Function | Name | Type | DPT | Flag |
|---------------|-------------------------|------------------|---------|-------|-----------------|
| 537, 549, 561 | Feedback colour hue (H) | Input... - Input | 1 bytes | 5,003 | C, (R), W, -, A |

1-byte object for receiving the colour hue.

- i** These objects are only visible with the following configuration:
- "Function" parameter = 3-byte RGB/HSV with colour wheel sequence
 - "Starting value of value adjustment" parameter = same as value from feedback object (1-byte/colour hue/H-value)

| Object no. | Function | Name | Type | DPT | Flag |
|---------------|--------------------------------|------------------|---------|---------|-----------------|
| 537, 549, 561 | Value transmitter feedback RGB | Input... - Input | 3 bytes | 232,600 | C, (R), W, -, A |

3-byte object for receiving 3-byte colour information.

- i** These objects are only visible with the following configuration:
- The "Function" parameter" = 3-byte RGB/HSV with colour wheel sequence or 3 byte RGB/HSV with brightness adjustment and
 - "Starting value of value adjustment" parameter = same as value from feedback object (3-byte RGB)

| Object no. | Function | Input... - Output | Type | DPT | Flag |
|---------------|---|-------------------|---------|---------|---------------|
| 531, 543, 555 | Colour temperature value transmitter + brightness | Input... - Output | 6 bytes | 249,600 | C, R, -, T, A |

6-byte object for sending the time window, colour temperature and brightness.

- i** These objects are only visible when:
- "Function = 6 bytes" and
 - "Value range = colour temperature value + brightness".

9.6 Scene extension

For each input whose function is set to "Scene extension device", a 1-byte communication object is available according to DPT 18.001. The "Function" parameter defines the specific operating function:

- "Scene extension without storage function",
- "Scene extension with storage function",

In the function as a scene extension, the device sends a preset scene number (1...64) to the KNX via the communication object when the contact at the input closes. This feature permits recalling scenes stored in other devices and also storing them, if the storage function is used.

Function for the setting "... Scene extension without storage function":

Closing the contact leads to easy retrieval of the scene. A long signal at the input has no further effect.

Function for the setting "... Scene extension with storage function":

Closing the contact with a signal length shorter than one second results in easy recall of the scene. If the signal at the input lasts longer than five seconds, the device generates a save command. In the scene extension function, a storage telegram is in this case transmitted to the KNX.

- i** A signal at the input with a time length between one and five seconds is rejected as invalid.

9.6.1 Scene extension parameters

Input... -> I... - Function

| | |
|---|--|
| Debounce time (10...255 ms) | 10...255 |
| This parameter sets the debouncing time individually for the input. According to the time set here, the input signal at the input is evaluated with a delay. | |
| Function | Scene extension without storage function Scene extension with storage function |
| <p>A signal at the input with a time length between one and five seconds is rejected as invalid.</p> <p>Scene extension without storage function: Closing the contact leads to simple retrieval of the scene. A long signal at the input has no further effect.</p> <p>Scene extension with storage function: Closing the contact with a signal length shorter than one second results in easy recall of the scene. If the signal at the input lasts longer than five seconds, the device generates a save command. In the scene extension function, a storage telegram is in this case transmitted to the KNX.</p> | |
| Scene number when closing the contact (1 ... 64) | 1...64 |
| In accordance with the KNX standard, objects with data type 18.001 can retrieve or store up to 64 scenes by their numbers. The parameter defines the scene number to be transmitted when the contact is closed. | |

9.6.2 Scene extension objects

| Object no. | Function | Name | Type | DPT | Flag |
|--|-----------------|-------------------|---------|--------|---------------|
| 592, 595, 598 | Scene extension | Input... - Output | 1 bytes | 18,001 | C, R, -, T, A |
| 1-byte object for recalling or storing one of max. 64 external KNX scenes. | | | | | |

9.7 2-channel operation

The "2-channel operation" function allows two function channels to be operated with only one input. This makes it possible to carry out two different functions with one contact and to send different types of telegrams.

For the two channels, the parameters "Function channel 1" and "Function channel 2" can be used independently of each other to determine which data formats the operating function uses in each case. The following functions are available:

- 1-bit switching
- Value transmitter 1 byte (0...255)
- Value transmitter 1 byte (0...100%)
- Value transmitter 1 byte (-128...127)
- Value transmitter 1 byte (0...255%)
- Value transmitter 1 byte (0 ... 360 °)
- Value transmitter 2 byte (0...65535)
- Value transmitter 2 byte (-32768...32767)
- Value transmitter 2-byte temperature value
- Value transmitter 2-byte brightness value
- Value transmitter 2 byte colour temperature value
- Value transmitter 3 byte colour value RGB/HSV
- Value transmitter 6 byte colour value RGBW/HSVW
- Value transmitter 6 byte colour temperature value + brightness
- Recalling scene (external)

Depending on the set function, the value command that the device sends to the KNX when the contact closes can be individually parameterised in the ETS. With "1 bit switching" it can be set whether an ON or OFF telegram is to be sent. Alternatively, the object value can be switched and sent at "UM".

With parameterization as a value transmitter "1 byte ..." or "2 byte ..." it is possible to select the object value within the intended value range. When used as a colour value transmitter "3 Byte..." the object values can be set according to RGB or HSV via a colour picker. With the colour value transmitter "6 byte..." the object values RGB or HSV are configured via a colour picker and the white value "W" via a slider.

When used as a value transmitter "6 byte colour temperature value + brightness", the object values colour temperature and brightness as well as a time window can be specified. With "Call scene (external)", the scene number is set which is to be sent out on the KNX when the contact closes.

The "Operation concept" parameter determines whether both channels or only one channel at a time sends the configured telegram when the contact closes.

Operation concept channel 1 or channel 2

With this operation concept, exactly one telegram is sent each time the contact is closed.

- With a short signal, the device only sends the telegram for channel 1.
- If the signal is long, the device only sends the telegram for channel 2.

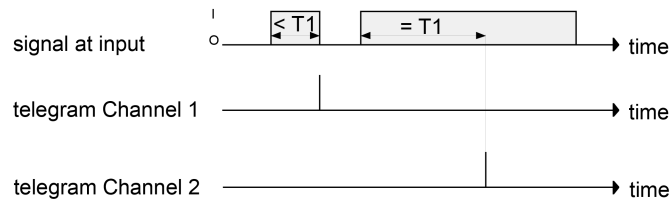

Image 24: Example of operation concept "Channel 1 or Channel 2"

The time duration ($T1$) for distinguishing between a short and a long signal is determined by the parameter "Time between channel 1 and channel 2". If the signal is shorter than the parameterised time, only the telegram to channel 1 is sent when the contact is opened. If the signal is longer, only the telegram to channel 2 is sent after time $T1$ has elapsed. This concept provides the transmission of only one channel.

Operation concept channel 1 and channel 2

With this operating concept, either only one or alternatively two telegrams are sent each time the contact is closed.

- With a short signal, the device only sends the telegram for channel 1.
- With a long signal, the device first sends the telegram for channel 1 and then the telegram for channel 2.

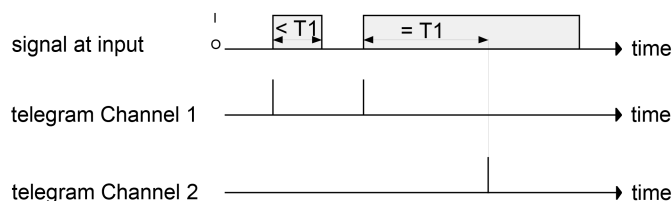

Image 25: Example for operation concept "Channel 1 and channel 2"

The time duration ($T1$) for distinguishing between a short and a long signal is determined by the parameter "Time between channel 1 and channel 2". When the contact is closed, the telegram for channel 1 is sent immediately. If the signal lasts longer than $T1$, the telegram for the second channel is also sent immediately after the time has elapsed. If the contact at the input is released before the time $T1$ has elapsed, the device does not send a telegram for channel 2.

9.7.1 2-channel operation parameters

Input... -> I... - Function

| | |
|--|---|
| Debounce time (10...255 ms) | 10...255 |
| This parameter sets the debouncing time individually for the input. According to the time set here, the input signal at the input is evaluated with a delay. | |
| Operation concept | Channel 1 or channel 2 Channel 1 and channel 2 |
| <p>This is where the 2-channel operation concept is defined.</p> <p>Channel 1 or channel 2: With this operating concept, exactly one telegram is sent each time the contact closes. The time duration for distinguishing between a short and a long signal is determined by the parameter "Time between channel 1 and channel 2". If the signal is shorter than the parameterised time, only the telegram to channel 1 is sent when the contact is opened. If the signal is longer, only the telegram to channel 2 is sent after time has elapsed. This concept provides the transmission of only one channel.</p> <p>Channel 1 and channel 2: With this operating concept, either only one or alternatively two telegrams are sent each time the contact closes. The time duration for distinguishing between a short and a long signal is determined by the parameter "Time between channel 1 and channel 2". When the contact is closed, the telegram for channel 1 is sent immediately. If the signal lasts longer than the set time, the telegram for the second channel is also sent immediately after the time has expired. If the contact at the input is released before the time has elapsed, the device does not send a telegram for channel 2.</p> | |

| | |
|--------------------|---|
| Function channel 1 | No function 1-bit switching 1 bytes (0...255) 1 byte (0...100%) 1 bytes (-128...127) 1 byte (0...255%) 1 byte (0...360°) 2 bytes (0...65535) 2 bytes (-32768...32767) 2 byte temperature value 2 byte brightness value 2 bytes colour temperature value 3 bytes colour value RGB/HSV 6 bytes colour value RGBW/HSVW 6 bytes colour temperature value + brightness Recalling scene (external) |
|--------------------|---|

This parameter determines the function of the first channel and defines which other parameters and which communication objects are displayed for channel 1.

| | |
|--------------------|---|
| Function channel 2 | No function 1-bit switching 1 bytes (0...255) 1 byte (0...100%) 1 bytes (-128...127) 1 byte (0...255%) 1 byte (0...360°) 2 bytes (0...65535) 2 bytes (-32768...32767) 2 byte temperature value 2 byte brightness value 2 bytes colour temperature value 3 bytes colour value RGB/HSV 6 bytes colour value RGBW/HSVW 6 bytes colour temperature value + brightness Recalling scene (external) |
|--------------------|---|

This parameter determines the function of the second channel and defines which other parameters and which communication objects are displayed for channel 2.

| | |
|---|-------------------------------|
| Colour space | RGB HSV |
| <p>This parameter defines the colour space of the function "3 byte colour value RGB/HSV".</p> <p>With "RGB", the data format of the communication objects can be set by the "Communication" parameter. With HSV, communication takes place via 1-byte individual objects.</p> | |
| Communication | Single object Kombi object |
| <p>This parameter defines the data format of the communication objects for the function "3 byte colour value RGB/HSV" in the colour space "RGB". Communication can take place via 1-byte individual objects or via a 3-byte combination object according to DPT 232.600.</p> | |
| Colour space | RGBW HSVW |
| <p>This parameter defines the colour space of the function "6 byte colour value RGBW/HSVW".</p> <p>With "RGBW", the data format of the communication objects can be set by the "Communication" parameter. With HSVW, communication takes place via 1-byte individual objects.</p> | |
| Communication | Single object Kombi object |
| <p>This parameter defines the data format of the communication objects for the function "3 byte colour value RGBW/HSVW" in the colour space "RGBW". Communication can take place via 1-byte individual objects or via a 6-byte combination object according to DPT 251.600.</p> | |
| Time between channel 1 and channel 2 (0...25 seconds) | 0... 3 ...25 |
| <p>Depending on the selected operation concept, this parameter defines the interval at which the device transmits the telegram for channel 1 and the telegram for channel 2.</p> <p>Setting the seconds of time between channel 1 and channel 2.</p> | |
| (0...990 milliseconds) | 0...990 |
| <p>Setting the milliseconds of time between channel 1 and channel 2.</p> | |
| Command for channel 1 (2) | ON OFF TOGGLE |
| <p>This parameter determines the object value that is sent out on the KNX when the contact closes. Visible only if "Function channel 1 (2) = 1 bit switching".</p> | |

| | |
|---|---------------------------------|
| Value (0...255) | 0...255 |
| This parameter determines the object value that is sent out on the KNX when the contact closes. Visible only if "Function channel 1 (2) = 1-byte (0...255)". | |
| Value (0...100%) | 0...100 |
| This parameter determines the object value that is sent out on the KNX when the contact closes. Visible only if "Function channel 1 (2) = 1-byte (0...100%)". | |
| Value (-128...127) | -128...0...127 |
| This parameter determines the object value that is sent out on the KNX when the contact closes. Visible only if "Function channel 1 (2) = 1-byte (-128...127)". | |
| Value (0...255%) | 0...255 |
| This parameter determines the object value that is sent out on the KNX when the contact closes. Visible only if "Function channel 1 (2) = 1-byte (0...255%)". | |
| Value (0...360°) | 0...360 |
| This parameter determines the object value that is sent out on the KNX when the contact closes. Visible only if "Function channel 1 (2) = 1-byte (0...360°)". | |
| Value (0...65535) | 0...65535 |
| This parameter determines the object value that is sent out on the KNX when the contact closes. Visible only if "Function channel 1 (2) = 2-byte (0...65535)". | |
| Value (-32768...32767) | -32768...0...32767 |
| This parameter determines the object value that is sent out on the KNX when the contact closes. Visible only if "Function channel 1 (2) = 2-byte (-32768...32767)". | |
| Temperature value (0...40 °C) | 0...20...40 |
| This parameter determines the object value that is sent out on the KNX when the contact closes. Visible only if "Function channel 1 (2) = 2-byte temperature value". | |
| Brightness value (0, 50, ..., 1500 lux) | 0...300...1500 |
| This parameter determines the object value that is sent out on the KNX when the contact closes. Visible only if "Function channel 1 (2) = 2-byte brightness value". | |
| Colour temperature value (1000, 1100, ..., 10000 K) | 1000, 1100, ...2700, ..., 10000 |
| This parameter determines the colour temperature value of the object value that is sent out on the KNX when the contact closes. It is only visible with "Function channel 1 (2) = 2 byte colour temperature value". | |

| | |
|---|---|
| Colour value (RGB/HSV) | #000000...#FFFFFF |
| <p>This parameter determines the object values when closing the contact for the following output objects:</p> <ul style="list-style-type: none"> – "Channel 1 (2) colour value red", "Channel 1 (2) colour value green", "Channel 1 (2) colour value blue" or – "Channel 1 (2) colour value RGB", "Channel 1 (2) colour value RGBW". <p>or</p> <ul style="list-style-type: none"> – "Channel 1 (2) colour hue (H)", "Channel 1 (2) saturation (S)", "Channel 1 (2) brightness (V)". <p>The parameter is only visible with "Function channel 1 (2) = 3 byte colour value RGB/HSV or 6 byte colour value RGBW/HSVW".</p> | |
| White level (W) | 0...255 |
| <p>This parameter determines the object values of the following output objects, which is sent out on the KNX when the contact closes:</p> <ul style="list-style-type: none"> – "Channel 1 (2) colour value white" or – "Channel 1 (2) colour value RGBW" <p>The parameter is only visible with "Function channel 1 (2) = 6 byte colour value RGBW/HSVW" in the colour space "RGB".</p> | |
| Value (W %) | 0...100 |
| <p>This parameter determines the object values of the following output objects, which is sent out on the KNX when the contact closes:</p> <ul style="list-style-type: none"> – Channel 1 (2) white level (W) <p>The parameter is only visible with "Function channel 1 (2) = 6 byte colour value RGBW/HSVW" in the colour space "HSV".</p> | |
| Colour temperature value (1000, 1100, ..., 10000 K) | 1000, 1100, ..., 2700 , ..., 10000 |
| <p>This parameter determines the object value for the colour temperature that is sent out on the KNX when the contact closes. It is only visible with "Function channel 1 (2) = 6 byte colour temperature value + brightness".</p> | |
| Brightness (0...100%) | 0...100 |
| <p>This parameter determines the object value for the brightness that is sent out on the KNX when the contact closes. It is only visible with "Function channel 1 (2) = 6 byte colour temperature value + brightness".</p> | |
| Time frame (0...100 minutes) | 0...100 |
| <p>This parameter determines the time period in which the actuator adjusts the colour temperature and brightness after the contact is closed. It is only visible with "Function channel 1 (2) = 6 byte colour temperature value + brightness".</p> <p>Setting the minutes of the time window.</p> | |

| | |
|---|------------|
| (0...59 seconds) | 0...1...59 |
| Setting the seconds of the time window. | |
| (0...900 milliseconds) | 0...900 |
| Setting the milliseconds of the time window. | |
| Scene number (1...64) for channel 1 (2) | 1...64 |
| This parameter determines the object value that is sent out on the KNX when the contact closes. It is only visible if "Function channel 1 (2) = Recalling scene (external)". | |

9.7.2 2-channel operation objects

| Object no. | Function | Name | Type | DPT | Flag |
|---|-------------------------------|-------------------|---------|-------|-----------------|
| 636, 649, 662 | Channel 1 switching | Input... - Output | 1-bit | 1,001 | C, (R), W, T, A |
| 1-bit object for transmitting switching telegrams on channel 1 if 2-channel operation is activated. | | | | | |
| Object no. | Function | Name | Type | DPT | Flag |
| 637, 650, 663 | Channel 2 switching | Input... - Output | 1-bit | 1,001 | C, -, W, T, U |
| 1-bit object for transmitting switching telegrams on channel 2 if 2-channel operation is activated. | | | | | |
| Object no. | Function | Name | Type | DPT | Flag |
| 636, 649, 662 | Channel 1 value 0...255 | Input... - Output | 1 bytes | 5,010 | C, R, -, T, A |
| 1-byte object for transmitting value telegrams on channel 1 if 2-channel operation is activated. | | | | | |
| Object no. | Function | Name | Type | DPT | Flag |
| 637, 650, 663 | Channel 2 value 0...255 | Input... - Output | 1 bytes | 5,010 | C, R, -, T, A |
| 1-byte object for transmitting value telegrams on channel 2 if 2-channel operation is activated. | | | | | |
| Object no. | Function | Name | Type | DPT | Flag |
| 636, 649, 662 | Channel 1 value 0...100 % | Input... - Output | 1 bytes | 5,001 | C, R, -, T, A |
| 1-byte object for transmitting value telegrams on channel 1 if 2-channel operation is activated. | | | | | |
| Object no. | Function | Name | Type | DPT | Flag |
| 637, 650, 663 | Channel 2 value 0...100 % | Input... - Output | 1 bytes | 5,001 | C, R, -, T, A |
| 1-byte object for transmitting value telegrams on channel 2 if 2-channel operation is activated. | | | | | |
| Object no. | Function | Name | Type | DPT | Flag |
| 636, 649, 662 | Channel 1 value -128...127 | Input... - Output | 1 bytes | 6,010 | C, R, -, T, A |
| 1-byte object for transmitting value telegrams on channel 1 if 2-channel operation is activated. | | | | | |

| Object no. | Function | Name | Type | DPT | Flag |
|--|-------------------------------|-------------------|---------|-------|---------------|
| 637, 650, 663 | Channel 2 value -128...127 | Input... - Output | 1 bytes | 6,010 | C, R, -, T, A |
| 1-byte object for transmitting value telegrams on channel 2 if 2-channel operation is activated. | | | | | |

| Object no. | Function | Name | Type | DPT | Flag |
|--|------------------------------|-------------------|---------|-------|---------------|
| 636, 649, 662 | Channel 1 value 0...255 % | Input... - Output | 1 bytes | 5,004 | C, R, -, T, A |
| 1-byte object for transmitting value telegrams on channel 1 if 2-channel operation is activated. | | | | | |

| Object no. | Function | Name | Type | DPT | Flag |
|--|------------------------------|-------------------|---------|-------|---------------|
| 637, 650, 663 | Channel 2 value 0...255 % | Input... - Output | 1 bytes | 5,004 | C, R, -, T, A |
| 1-byte object for transmitting value telegrams on channel 2 if 2-channel operation is activated. | | | | | |

| Object no. | Function | Name | Type | DPT | Flag |
|--|-----------------------------|-------------------|---------|-------|---------------|
| 636, 649, 662 | Channel 1 value 0...360° | Input... - Output | 1 bytes | 5,003 | C, R, -, T, A |
| 1-byte object for transmitting value telegrams on channel 1 if 2-channel operation is activated. | | | | | |

| Object no. | Function | Name | Type | DPT | Flag |
|--|-----------------------------|-------------------|---------|-------|---------------|
| 637, 650, 663 | Channel 2 value 0...360° | Input... - Output | 1 bytes | 5,003 | C, R, -, T, A |
| 1-byte object for transmitting value telegrams on channel 2 if 2-channel operation is activated. | | | | | |

| Object no. | Function | Name | Type | DPT | Flag |
|--|------------------------------|-------------------|---------|-------|---------------|
| 636, 649, 662 | Channel 1 value 0...65535 | Input... - Output | 2 bytes | 7,001 | C, R, -, T, A |
| 2-byte object for transmitting value telegrams on channel 1 if 2-channel operation is activated. | | | | | |

| Object no. | Function | Name | Type | DPT | Flag |
|--|------------------------------|-------------------|---------|-------|---------------|
| 637, 650, 663 | Channel 2 value 0...65535 | Input... - Output | 2 bytes | 7,001 | C, R, -, T, A |
| 2-byte object for transmitting value telegrams on channel 2 if 2-channel operation is activated. | | | | | |

| Object no. | Function | Name | Type | DPT | Flag |
|--|-----------------------------------|-------------------|---------|-------|---------------|
| 636, 649, 662 | Channel 1 value -32768...32767 | Input... - Output | 2 bytes | 8,001 | C, R, -, T, A |
| 2-byte object for transmitting value telegrams on channel 1 if 2-channel operation is activated. | | | | | |

| Object no. | Function | Name | Type | DPT | Flag |
|--|-----------------------------------|-------------------|---------|-------|---------------|
| 637, 650, 663 | Channel 2 value -32768...32767 | Input... - Output | 2 bytes | 8,001 | C, R, -, T, A |
| 2-byte object for transmitting value telegrams on channel 2 if 2-channel operation is activated. | | | | | |

| Object no. | Function | Name | Type | DPT | Flag |
|---|----------------------------------|-------------------|---------|-------|---------------|
| 636, 649, 662 | Channel 1 temperat- ure value | Input... - Output | 2 bytes | 9,001 | C, R, -, T, A |
| 2-byte object for transmitting temperature values on channel 1 if 2-channel operation is activated. | | | | | |

| Object no. | Function | Name | Type | DPT | Flag |
|---|----------------------------------|-------------------|---------|-------|---------------|
| 637, 650, 663 | Channel 2 temperat- ure value | Input... - Output | 2 bytes | 9,001 | C, R, -, T, A |
| 2-byte object for transmitting temperature values on channel 2 if 2-channel operation is activated. | | | | | |

| Object no. | Function | Name | Type | DPT | Flag |
|--|---------------------------------|-------------------|---------|-------|---------------|
| 636, 649, 662 | Channel 1 bright- ness value | Input... - Output | 2 bytes | 9,004 | C, R, -, T, A |
| 2-byte object for transmitting brightness values on channel 1 if 2-channel operation is activated. | | | | | |

| Object no. | Function | Name | Type | DPT | Flag |
|--|---------------------------------|-------------------|---------|-------|---------------|
| 637, 650, 663 | Channel 2 bright- ness value | Input... - Output | 2 bytes | 9,004 | C, R, -, T, A |
| 2-byte object for transmitting brightness values on channel 2 if 2-channel operation is activated. | | | | | |

| Object no. | Function | Name | Type | DPT | Flag |
|---|---------------------------------------|-------------------|---------|-------|---------------|
| 636, 649, 662 | Channel 1 colour temperature value | Input... - Output | 2 bytes | 7,600 | C, R, -, T, A |
| 2-byte object for sending colour temperature values from 1000 to 10000 Kelvin on channel 1 if 2-channel operation is activated. | | | | | |

| Object no. | Function | Name | Type | DPT | Flag |
|---|------------------------------------|-------------------|---------|-------|---------------|
| 637, 650, 663 | Channel 2 colour temperature value | Input... - Output | 2 bytes | 7,600 | C, R, -, T, A |
| 2-byte object for sending colour temperature values from 1000 to 10000 Kelvin on channel 2 if 2-channel operation is activated. | | | | | |

| Object no. | Function | Name | Type | DPT | Flag |
|--|----------------------------|-------------------|---------|---------|---------------|
| 636, 649, 662 | Channel 1 colour value RGB | Input... - Output | 3 bytes | 232,600 | C, R, -, T, A |
| 3-byte object for sending the colour information red, green and blue in a communication object on channel 1 if 2-channel operation is activated. | | | | | |

| Object no. | Function | Name | Type | DPT | Flag |
|--|----------------------------|-------------------|---------|---------|---------------|
| 637, 650, 663 | Channel 2 colour value RGB | Input... - Output | 3 bytes | 232,600 | C, R, -, T, A |
| 3-byte object for sending the colour information red, green and blue in a communication object on channel 2 if 2-channel operation is activated. | | | | | |

| Object no. | Function | Name | Type | DPT | Flag |
|---|-----------------------------|-------------------|---------|---------|---------------|
| 636, 649, 662 | Channel 1 colour value RGBW | Input... - Output | 6 bytes | 251,600 | C, R, -, T, A |
| 6-byte object for sending the colour information red, green, blue and white in a communication object on channel 1 if 2-channel operation is activated. | | | | | |

| Object no. | Function | Name | Type | DPT | Flag |
|---|-----------------------------|-------------------|---------|---------|---------------|
| 637, 650, 663 | Channel 2 colour value RGBW | Input... - Output | 6 bytes | 251,600 | C, R, -, T, A |
| 6-byte object for sending the colour information red, green, blue and white in a communication object on channel 2 if 2-channel operation is activated. | | | | | |

| Object no. | Function | Name | Type | DPT | Flag |
|--|----------------------------|-------------------|---------|-------|---------------|
| 638, 651, 664 | Channel 1 colour value red | Input... - Output | 1 bytes | 5,001 | C, R, -, T, A |
| 1-byte object for sending the colour value red from 0 to 100 percent on channel 1 if 2-channel operation is activated. | | | | | |

| Object no. | Function | Name | Type | DPT | Flag |
|--|----------------------------|-------------------|---------|-------|---------------|
| 642, 655, 668 | Channel 2 colour value red | Input... - Output | 1 bytes | 5,001 | C, R, -, T, A |
| 1-byte object for sending the colour value red from 0 to 100 percent on channel 2 if 2-channel operation is activated. | | | | | |

| Object no. | Function | Name | Type | DPT | Flag |
|---------------|------------------------------|-------------------|---------|-------|---------------|
| 639, 652, 665 | Channel 1 colour value green | Input... - Output | 1 bytes | 5,001 | C, R, -, T, A |

1-byte object for sending the colour value green from 0 to 100 percent on channel 1 if 2-channel operation is activated.

| Object no. | Function | Name | Type | DPT | Flag |
|---------------|------------------------------|-------------------|---------|-------|---------------|
| 643, 656, 669 | Channel 2 colour value green | Input... - Output | 1 bytes | 5,001 | C, R, -, T, A |

1-byte object for sending the colour value green from 0 to 100 percent on channel 2 if 2-channel operation is activated.

| Object no. | Function | Name | Type | DPT | Flag |
|---------------|-----------------------------|-------------------|---------|-------|---------------|
| 640, 653, 666 | Channel 1 colour value blue | Input... - Output | 1 bytes | 5,001 | C, R, -, T, A |

1-byte object for sending the colour value blue from 0 to 100 percent on channel 1 if 2-channel operation is activated.

| Object no. | Function | Name | Type | DPT | Flag |
|---------------|-----------------------------|-------------------|---------|-------|---------------|
| 644, 657, 670 | Channel 2 colour value blue | Input... - Output | 1 bytes | 5,001 | C, R, -, T, A |

1-byte object for sending the colour value blue from 0 to 100 percent on channel 2 if 2-channel operation is activated.

| Object no. | Function | Name | Type | DPT | Flag |
|---------------|--|-------------------|---------|-------|---------------|
| 641, 654, 667 | Channel 1 colour value transmitter white | Input... - Output | 1 bytes | 5,001 | C, R, -, T, A |

1-byte object for sending the colour value white from 0 to 100 percent on channel 1 if 2-channel operation is activated.

| Object no. | Function | Name | Type | DPT | Flag |
|---------------|--|-------------------|---------|-------|---------------|
| 645, 658, 671 | Channel 2 colour value transmitter white | Input... - Output | 1 bytes | 5,001 | C, R, -, T, A |

1-byte object for sending the colour value white from 0 to 100 percent on channel 2 if 2-channel operation is activated.

| Object no. | Function | Name | Type | DPT | Flag |
|---------------|--------------------------|-------------------|---------|-------|---------------|
| 638, 651, 664 | Channel 1 colour hue (H) | Input... - Output | 1 bytes | 5,003 | C, R, -, T, A |

1-byte object for sending the colour angle (H) from 0 ... 360° on channel 1 if 2-channel operation is activated.

| Object no. | Function | Name | Type | DPT | Flag |
|--|--------------------------|-------------------|---------|-------|---------------|
| 642, 655, 668 | Channel 2 colour hue (H) | Input... - Output | 1 bytes | 5,003 | C, R, -, T, A |
| 1-byte object for sending the colour angle (H) from 0 ... 360° on channel 2 if 2-channel operation is activated. | | | | | |

| Object no. | Function | Name | Type | DPT | Flag |
|--|--------------------------|-------------------|---------|-------|---------------|
| 639, 652, 665 | Channel 1 saturation (S) | Input... - Output | 1 bytes | 5,001 | C, R, -, T, A |
| 1-byte object for sending the saturation (S) from 0 to 100 percent on channel 1 if 2-channel operation is activated. | | | | | |

| Object no. | Function | Name | Type | DPT | Flag |
|--|--------------------------|-------------------|---------|-------|---------------|
| 643, 656, 669 | Channel 2 saturation (S) | Input... - Output | 1 bytes | 5,001 | C, R, -, T, A |
| 1-byte object for sending the saturation (S) from 0 to 100 percent on channel 2 if 2-channel operation is activated. | | | | | |

| Object no. | Function | Name | Type | DPT | Flag |
|--|--------------------------|-------------------|---------|-------|---------------|
| 640, 653, 666 | Channel 1 brightness (V) | Input... - Output | 1 bytes | 5,001 | C, R, -, T, A |
| 1-byte object for sending the brightness value (V) from 0 to 100 percent on channel 1 if 2-channel operation is activated. | | | | | |

| Object no. | Function | Name | Type | DPT | Flag |
|--|--------------------------|-------------------|---------|-------|---------------|
| 644, 657, 670 | Channel 2 brightness (V) | Input... - Output | 1 bytes | 5,001 | C, R, -, T, A |
| 1-byte object for sending the brightness value (V) from 0 to 100 percent on channel 2 if 2-channel operation is activated. | | | | | |

| Object no. | Function | Name | Type | DPT | Flag |
|---|---------------------------|-------------------|---------|-------|---------------|
| 641, 654, 667 | Channel 1 white level (W) | Input... - Output | 1 bytes | 5,001 | C, R, -, T, A |
| 1-byte object for sending the white value (W) from 0 to 100 percent on channel 1 if 2-channel operation is activated. | | | | | |

| Object no. | Function | Name | Type | DPT | Flag |
|---|---------------------------|-------------------|---------|-------|---------------|
| 645, 658, 671 | Channel 2 white level (W) | Input... - Output | 1 bytes | 5,001 | C, R, -, T, A |
| 1-byte object for sending the white value (W) from 0 to 100 percent on channel 2 if 2-channel operation is activated. | | | | | |

| Object no. | Function | Name | Type | DPT | Flag |
|--|---|-------------------|---------|---------|---------------|
| 636, 649, 662 | Channel 1 colour temperature value + brightness | Input... - Output | 6 bytes | 249,600 | C, R, -, T, A |
| 6-byte object for sending the time window, colour temperature and brightness on channel 1 if 2-channel operation is activated. | | | | | |

| Object no. | Function | Name | Type | DPT | Flag |
|--|---|-------------------|---------|---------|---------------|
| 637, 650, 663 | Channel 1 colour temperature value + brightness | Input... - Output | 6 bytes | 249,600 | C, R, -, T, A |
| 6-byte object for sending the time window, colour temperature and brightness on channel 2 if 2-channel operation is activated. | | | | | |

| Object no. | Function | Name | Type | DPT | Flag |
|---|-----------------------------------|-------------------|---------|--------|---------------|
| 636, 649, 662 | Channel 1 scene (external) 1...64 | Input... - Output | 1 bytes | 18,001 | C, R, -, T, A |
| 1-byte object for transmitting scene values on channel 1 if 2-channel operation is activated. | | | | | |

| Object no. | Function | Name | Type | DPT | Flag |
|---|-----------------------------------|-------------------|---------|--------|---------------|
| 637, 650, 663 | Channel 2 scene (external) 1...64 | Input... - Output | 1 bytes | 18,001 | C, R, -, T, A |
| 1-byte object for transmitting scene values on channel 2 if 2-channel operation is activated. | | | | | |

9.8 Controller extension

The function "controller extension" can be used to control a KNX room temperature controller. The controller extension itself is not involved in the regulating process. With it, the user can operate the single-room regulation from different places in the room. It can also be used to adjust central heating control devices which are located, for instance, in a sub-distribution device.

Typical KNX room temperature controllers generally offer different ways of influencing the room temperature control:

- Operating mode switch:
Switching over between different modes of operation (e.g. "Comfort", "Night" ...) with different setpoint temperatures assigned to each mode by the controller.
- Presence function:
Signalling the presence of a person in a room. The signalling may also be combined with a configured switchover in the mode of operation.
- Setpoint shift:
Adjustment of the setpoint temperature via a temperature offset (DPT 9.002) or via levels (DPT 6.010).

The controller extension is operated by the input functions of the device. In this way, it is possible to completely control a room temperature controller by changing the operating mode, by predefining the presence function or by readjusting the setpoint shift.

9.8.1 Operating mode switchover

The switching of the controller operating mode can be carried out with two 1-byte communication objects in accordance with the KNX specification for room temperature controllers. The operating mode can be switched over with the normal and with the forced objects. The "Operating mode switchover" object offers a selection between the following modes:

- Comfort mode
- Standby mode
- Night operation
- Frost/heat protection mode

The "Forced object operating mode" communication object has a higher priority. It permits forced switching between the following modes of operation:

- Auto (normal operating mode switchover)
- Comfort mode
- Standby mode
- Night operation
- Frost/heat protection mode

i Notes on multiple selection: In order to ensure that a change-over from one operating mode to another works properly even from different locations, the operating mode objects of the controller and those of all controller extensions must be interlinked. By checking the linked operating mode switchover feedback object, the controller extension knows which of the possible operating modes is active. Based on this information, the system switches to the next operating mode when the contact is closed. In the event that none of the possible operating modes is active, the next operating mode in the sequence is activated. As far as switching over between the forced operating modes and "Auto" is concerned, the device switches into the "Auto" operating mode when none of the configured operating modes is active.

9.8.2 Presence function

In the "Presence function" function mode, the two communication objects "Presence function" and "Presence function feedback" are available. The "Presence function when closing the contact" parameter determines the object value that is sent out on the KNX when the contact at the input closes.

To ensure that the appropriate object value is always sent with the "Presence TOGGLE" setting, the presence object of the room temperature controller and the feedback objects of the controller extension devices must be connected to each other via a separate group address (this group address must be transmitting at the controller).

9.8.3 Setpoint shift

The setpoint shift is another available function of the controller extension. It makes use of either two 2-byte communication objects with datapoint type 9.002 or two 1-byte communication objects with datapoint type 6.010 (integer with sign).

This extension function allows shifting of the basic setpoint for the temperature on a room temperature controller by signals at the input. Operation of the extension is generally the same as the operation of the main controller. An input parameterised as setpoint shift decreases or increases the value of the setpoint shift once each time the contact closes. The direction of the value adjustment is determined by the parameters "Temperature difference when closing the contact" or "Setpoint shift when closing the contact".

Type of setpoint shift

The device provides two options for setpoint shifting. Depending on the setting of the parameter "Type of setpoint shift", the shift takes place via the 2-byte communication object "Setpoint shift specification" (acc. to KNX DPT 9.002) or via the 1-byte-communication object "Setpoint shift specification" (acc. to KNX DPT 6.010).

The setting "Via offset (DPT 9.002)" defines the temperature difference in Kelvin by which the setpoint temperature will be shifted up or down when the contact is closed. For a setpoint value shift, the controller extension makes use of the two communication objects "Setpoint shift specification" and "Current setpoint shift". The "Current setpoint shift" communication object informs the extension about the current state of the room temperature controller. Based on this value and the respective parameter, the controller extension determines the new level size which it transmits via the "Setpoint shift specification" communication object to the room temperature controller.

With the "Via levels (DPT 6.010)" setting, only the direction of the setpoint shift on the extension is defined. For a setpoint value shift, the controller extension makes use of the two communication objects "Setpoint shift specification" and "Current setpoint shift". The "Current setpoint shift" communication object informs the extension about the current state of the room temperature controller. Based on this value and the respective parameter, the controller extension determines the new level size which it transmits via the "Setpoint shift specification" communication object to the room temperature controller.

Communication with main controller

In order to enable the device to effect a setpoint shift in a room temperature controller, the controller must have input and output objects for setpoint shifting. In this case, the output object of the controller must be linked with the input object of the extension device and the input object of the controller must be linked with the output object of the extension via an independent group address.

All objects are of the same datapoint type and have the same value range. A setpoint shift is interpreted by count values: a shift in positive direction is expressed by positive values whereas a shift in negative direction is represented by negative object values. An object value of "0" means that no setpoint shift has been activated.

Via the "Current setpoint shift" object of the controller extensions, which is linked with the room temperature controller, the extensions are enabled to determine the current setpoint shift position. Based on the value of the communication object, the setpoint is adjusted in the configured direction each time the contact at an extension closes. Each time the setpoint is adjusted, the new shift is transmitted to the room temperature controller via the "Controller extension setpoint value specification" object of the controller extension. The controller itself checks the received value for the minimum and maximum temperature limits (see controller documentation) and adjusts the new setpoint shift if the values are valid. When the new count value is accepted as valid, the controller transfers this value to its output object for setpoint shifting and retransmits the value to the extension as feedback.

Due to the standard data point type used as the output and input object of the controller extension, each extension device is able to determine whether a shift took place, in which direction it took place and by which value (DPT 9.002) or by how many levels (DPT 6.010) the setpoint was shifted.

- i In "Via levels (DPT 6.010)" function, the weighting of the respective level is done by the controller itself.
- i This requires that the communication objects are connected on all controller extensions and the controller. The feedback information from the controller enables the extension to continue the adjustment anytime at the right point.

9.8.4 Controller extension parameters

Input... -> I... - Function

| | |
|--|--|
| Debounce time (10...255 ms) | 10...255 |
| This parameter sets the debouncing time individually for the input. According to the time set here, the input signal at the input is evaluated with a delay. | |
| Function | Operating mode switchover Forced oper. mode switchover Presence function Setpoint shift |
| A controller extension can optionally switch over the operating mode with normal or high priority (forced), change the presence state or change the current room temperature setpoint value. With regard to the setting of this parameter, the ETS shows further parameters. | |
| Operating mode when closing the contact | Comfort mode Standby mode Night operation Frost/heat protection mode Comfort mode -> Standby mode ->* Comfort mode -> Night mode ->* Standby mode -> Night mode ->* Comfort mode -> Standby mode -> Night mode ->* |
| If the controller extension is to change over the operating mode of the room temperature controller with normal priority, the extension can – when operated – either switch on a defined operating mode or change over between different operating modes. This parameter is only visible if "Function = operating mode switchover". | |

| | |
|--|--|
| <p>Forced operating mode when closing the contact</p> | <p>Auto (Normal operating mode change-over) Comfort mode Standby mode Night operation Frost/heat protection mode Comfort mode -> Standby mode ->* Comfort mode -> Night mode ->* Standby mode -> Night mode ->* Comfort mode -> Standby mode -> Night mode ->* Auto -> Comfort mode ->* Auto -> Standby mode ->* Auto -> Night mode ->* Auto -> Frost/heat protection mode ->*</p> |
| <p>If the controller extension is to change over the operating mode of the room temperature controller with high priority, the extension can – when operated – either enable change-over with normal priority (Auto), switch on a defined operating mode with high priority or change over between different operating modes. This parameter is only visible if "Function = forced operating mode switchover".</p> | |
| <p>Presence function when closing the contact</p> | <p>Presence OFF Presence ON Presence TOGGLE</p> |
| <p>On closing the contact, the controller extension can switch the presence state of the room temperature controller either on or off in a defined way or change over between both states ("Presence TOGGLE"). This parameter is only visible if "Function = presence function".</p> | |
| <p>Type of setpoint shift</p> | <p>Via offset (DPT 9.002) Via levels (DPT 6.010)</p> |
| <p>Depending on the setting of this parameter, the shift takes place via the 2-byte communication object "Setpoint shift specification" (acc. to KNX DPT 9.002) or via the 1-byte-communication object "Setpoint shift specification" (acc. to KNX DPT 6.010). This parameter is only visible if "Function = Setpoint shift".</p> | |

| | |
|---|---------------|
| Temperature difference when closing the contact | +2 K |
| | +1.5 K |
| | +1 K |
| | +0.5 K |
| | -0.5 K |
| | -1 K |
| | -1.5 K |
| | -2 K |

The temperature difference is defined in Kelvin here by which the setpoint temperature will be shifted up or down when the contact is closed.

For a setpoint value shift, the controller extension makes use of the two communication objects "Setpoint shift specification" and "Current setpoint shift".

The "Current setpoint shift" communication object informs the extension about the current state of the room temperature controller. Based on this value and the respective parameter, the controller extension determines the new level size which it transmits via the "Setpoint shift specification" communication object to the room temperature controller.

This parameter is only visible if "Function = Setpoint shift" and "Type of setpoint shift = Via offset (DPT 9.002)".

| | |
|---|---------------------------------------|
| Setpoint shift when closing the contact | Increase setpoint (level size) |
| | Reduce setpoint value (level size) |

This parameter defines the direction of the setpoint shift on the extension.

For a setpoint value shift, the controller extension makes use of the two communication objects "Setpoint shift specification" and "Current setpoint shift".

The "Current setpoint shift" communication object informs the extension about the current state of the room temperature controller. Based on this value and the respective parameter, the controller extension determines the new level size which it transmits via the "Setpoint shift specification" communication object to the room temperature controller.

This parameter is only visible if "Function = Setpoint shift" and "Type of setpoint shift = Via levels (DPT 6.010)".

9.8.5 Controller extension objects

| Object no. | Function | Name | Type | DPT | Flag |
|--|--|-------------------|---------|--------|---------------|
| 606, 613, 620 | Controller extension operating mode switchover | Input... - Output | 1 bytes | 20,102 | C, R, -, T, A |
| <p>1-byte object for changing over a room temperature controller between the Comfort, Standby, Night and Frost/heat protection operating modes.</p> <p>This object is only visible if "Function = operating mode change-over".</p> | | | | | |

| Object no. | Function | Name | Type | DPT | Flag |
|--|---|------------------|---------|--------|-----------------|
| 607, 614, 621 | Controller extension operating mode switchover feedback | Input... - Input | 1 bytes | 20,102 | C, (R), W, -, A |
| <p>1-byte object for receiving the operating mode of a room temperature controller.</p> <p>This object is only visible if "Function = operating mode change-over".</p> | | | | | |

| Object no. | Function | Name | Type | DPT | Flag |
|--|--|-------------------|---------|--------|---------------|
| 606, 613, 620 | Controller extension forced-object operating | Input... - Output | 1 bytes | 20,102 | C, R, -, T, A |
| <p>1-byte object for changing over a room temperature controller under forced control between the Automatic, Comfort, Standby, Night and Frost / heat protection operating modes</p> <p>This object is only visible if "Function = forced operating mode change-over".</p> | | | | | |

| Object no. | Function | Name | Type | DPT | Flag |
|---|---|------------------|---------|--------|-----------------|
| 607, 614, 621 | Controller extension forced-object operating feedback | Input... - Input | 1 bytes | 20,102 | C, (R), W, -, A |
| <p>1-byte object for receiving the operating mode of a room temperature controller.</p> <p>This object is only visible if "Function = forced operating mode change-over".</p> | | | | | |

| Object no. | Function | Name | Type | DPT | Flag |
|---|--|-------------------|-------|-------|---------------|
| 606, 613, 620 | Controller extension presence function | Input... - Output | 1-bit | 1,018 | C, R, -, T, A |
| <p>1-bit object for changing over the presence status of a room temperature controller.</p> <p>This object is only visible if "Function = presence function".</p> | | | | | |

| Object no. | Function | Name | Type | DPT | Flag |
|---|---|------------------|-------|-------|-----------------|
| 607, 614, 621 | Controller extension presence function feedback | Input... - Input | 1-bit | 1,018 | C, (R), W, -, A |
| <p>1-bit object for receiving the presence status of a room temperature controller.</p> <p>This object is only visible if "Function = presence function".</p> | | | | | |

| Object no. | Function | Name | Type | DPT | Flag |
|---------------|---|-------------------|---------|-------|---------------|
| 606, 613, 620 | Controller extension setting setpoint shift | Input... - Output | 2 bytes | 9,002 | C, R, -, T, A |

2-byte object for presetting a basic setpoint shift in Kelvin. The value "0" means that no shift is active . The values can be specified between -670760 K and 670760 K.

This object is only visible if "Function = Setpoint shift" and "Type of setpoint shift = Via offset (DPT 9.002)".

| Object no. | Function | Name | Type | DPT | Flag |
|---------------|--|------------------|---------|-------|-----------------|
| 607, 614, 621 | Controller extension actual setpoint shift | Input... - Input | 2 bytes | 9,002 | C, (R), W, -, A |

2-byte object for receiving the feedback from the current basic setpoint shift in Kelvin.

This object is only visible if "Function = Setpoint shift" and "Type of setpoint shift = Via offset (DPT 9.002)".

| Object no. | Function | Name | Type | DPT | Flag |
|---------------|---|-------------------|---------|-------|---------------|
| 606, 613, 620 | Controller extension setting setpoint shift | Input... - Output | 1 bytes | 6,010 | C, R, -, T, A |

1-byte object for presetting a basic setpoint shift. The value "0" means that no shift is active . The value is depicted in a two's complement in the positive or negative direction.

This object is only visible if "Function = Setpoint shift" and "Type of setpoint shift = Via levels (DPT 6.010)".

| Object no. | Function | Name | Type | DPT | Flag |
|---------------|--|------------------|---------|-------|-----------------|
| 607, 614, 621 | Controller extension actual setpoint shift | Input... - Input | 1 bytes | 6,010 | C, (R), W, -, A |

1-byte object for receiving the feedback from the current basic setpoint shift.

This object is only visible if "Function = Setpoint shift" and "Type of setpoint shift = Via levels (DPT 6.010)".

9.9 Temperature measurement

Introduction

It is possible to connect an NTC temperature sensor to input 3 for measuring a floor or room temperature. If input 3 is used as an input for a temperature sensor, parameters are available in the application program that define the acquisition of the measured value, the temperature adjustment and the transmission behaviour of the temperature value. The wired temperature sensor can be combined with an external temperature value. This makes it possible to form one measured value from up to two measured values.

- i** When connecting to input 3, only use the NTC temperature sensor listed in the accessories. Functional errors may occur with other sensors.

If the "Function" parameter for input 3 is set to "Temperature sensor (NTC)", temperature measurement can be used. Depending on the application, the temperature can then be recorded by the wired sensor and optionally supplemented by a temperature value received from the KNX from another measuring point. The parameter "Measurement by" defines the temperature measurement by either one or two sensors.

When selecting the mounting location of the temperature sensors, the following points should be considered:

- Do not install the temperature sensor in the area of large electrical consumers (avoid heat influences).
- The push button sensor should not be installed in the vicinity of radiators or cooling systems.
- The temperature sensor should not be exposed to direct sun.
- The installation of sensors on the inside of an outside wall might have a negative impact on the temperature measurement.
- Temperature sensors should be installed at least 30 cm away from doors, windows or ventilation devices and at least 1.5 m above the floor.

Temperature detection and measured value formation

The "Measurement by" parameter specifies which sensors are used to determine the temperature. The following settings are possible:

- wired sensor (input 3)
The temperature value is determined exclusively by the NTC temperature sensor connected to input 3. With this configuration, temperature measurement starts a few seconds after a device reset (bus voltage return, ETS programming operation).
- wired sensor (input 3) and external sensor (object)
With this setting, two temperature sensors are combined. The temperature is determined by the NTC temperature sensor connected to input 3 and also by a temperature value received from the KNX. This external sensor is coupled via the 2-byte object "External sensor" and can be a KNX room thermostat or a controller extension with temperature detection.

The "Measured value formation" parameter defines the weighting of the temperature values. It is possible to adjust the temperature measurement depending on different installation locations of the sensors or a different heat distribution in the room. Often, those temperature sensors that are subject to negative external influences (for example, unfavourable location because of exposure to sun or heater or door / window directly next to it) are weighted less heavily. Example: The wired sensor is mounted on an interior wall in the middle of the room below the ceiling. Another push-button sensor with temperature measurement is mounted next to the room entrance door.

Wired sensor: 21.5 °C

External sensor (push-button sensor): 22.3 °C

Determination of measured value: 30 % to 70 %

$$\rightarrow T_{\text{Result wired}} = T_{\text{wired}} \cdot 0.3 = 6.45 \text{ °C},$$

$$\rightarrow T_{\text{Result 2}} = T_2 = 22.3 \text{ °C} \cdot 0.7 = 15.61 \text{ °C}$$

$$\rightarrow T_{\text{Result is}} = T_{\text{Result wired}} + T_{\text{Result extern}} = \underline{22.06 \text{ °C}}$$

The device can request the external temperature value cyclically. To do this, the "Polling time of external sensor" parameter must be set to a time > 0 minutes.

A few seconds after a device reset (bus voltage return, ETS programming operation), the temperature measurement starts. If no temperature value has yet been received via the "External sensor" object when evaluating an external temperature sensor, only the value formed by the internal sensor is processed.

Calibrating the measured values

In some cases, it may be necessary in the course of temperature measurement to match the measured values of the wired sensor and the external sensor (received temperature value). Adjustment becomes necessary, for example, if the temperature measured by the sensors stays permanently below or above the actual temperature in the vicinity of the sensor. To determine the temperature deviation, the actual room temperature should be detected with a reference measurement using a calibrated temperature measuring device.

The positive (temperature increase, 1 ..127 K) or negative (temperature decrease, -128...-1 K) temperature adjustment can be parameterised in 0.1 K steps using the parameters "Wired sensor adjustment" and " External sensor adjustment". The adjustment is thus statically set only once and is the same for all operating states of the temperature measurement.

- i** The measured value must be raised if the value measured by the sensor is below the actual temperature. The measured value must be lowered if the value measured by the sensor is above the actual temperature.

Sending the determined temperature

The determined temperature can be actively transmitted to the KNX via the 2-byte "Actual temperature" object. The parameter "Transmit on change by" defines the temperature change by which the actual temperature value must change so that the value is automatically sent out via the object. Setting to "0" at this point will deactivate the automatic transmission of the actual temperature.

In addition, the actual temperature can be transmitted cyclically. The parameter determines the cycle time. The value "0" will deactivate the periodical transmission of the actual temperature value.

- i** Setting the "Read" flag on the "actual temperature" object makes it possible to read out the current temperature value at any time over the KNX. It has to be pointed out that with deactivated periodical transmission and deactivated automatic transmission, no more actual-temperature telegrams will be transmitted".

After bus voltage return or after an ETS programming operation, the object value is updated after a few seconds according to the current actual temperature value and transmitted to the KNX. The set "Delay after bus voltage return" is taken into account. If no temperature value has yet been received via the "External sensor" object when evaluating an external temperature sensor, only the value formed by the internal sensor is processed.

9.9.1 Temperature measurement parameters

Input... -> I... - Function

| | |
|---|--|
| Measurement by | wired sensor (input 3) wired sensor (input 3) and external sensor (object) |
| <p>This parameter determines which sensor is used for temperature measurement.</p> <p>wired sensor (input 3): The temperature value is determined exclusively by the NTC temperature sensor connected to input 3. With this configuration, temperature measurement starts a few seconds after a device reset (bus voltage return, ETS programming operation).</p> <p>wired sensor (input 3) and external sensor (object): With this setting, two temperature sensors are combined. The temperature is determined by the NTC temperature sensor connected to input 3 and also by a temperature value received from the KNX. This external sensor is coupled via the 2-byte object "External sensor" and can be a KNX room thermostat or a controller extension with temperature detection. A few seconds after a device reset (bus voltage return, ETS programming operation), the temperature measurement starts. If no temperature value has yet been received via the "External sensor" object when evaluating an external temperature sensor, only the value formed by the internal sensor is processed.</p> | |
| Measured value formation | wired 10% to external 90% wired 20% to external 80% wired 30% to external 70% wired 40% to external 60% wired 50% to external 50% wired 60% to external 40% wired 70% to external 30% wired 80% to external 20% wired 90% to external 10% |
| <p>The weighting of the measured temperature value for the wired and external sensors is specified here. This forms a resulting total measured value that is used for further evaluation of the actual temperature.</p> <p>It is possible to adjust the temperature measurement depending on different installation locations of the sensors or a different heat distribution in the room. Often, those temperature sensors that are subject to negative external influences (for example, unfavourable location because of exposure to sun or heater or door / window directly next to it) are weighted less heavily.</p> | |
| Wired sensor adjustment (-12.8...12.7 K) | -12.8...0...12.7 |
| This parameter adjusts the measured value of the wired sensor. | |
| External sensor calibration (-12.8...12.7 K) | -12.8...0...12.7 |
| This parameter adjusts the measured value of the external sensor. The parameter is only visible if the temperature is also measured by the external sensor. | |

| | |
|---|----------------|
| Polling time of external sensor (0...255 minutes) | 0...255 |
| The polling time for the external sensor's temperature value is specified here. In the "0" setting, the external sensor is not automatically polled. In this case, the sensor must transmit its temperature value itself. | |
| Transmit on change by (0..25.5 K) | 0...0.2...25.5 |
| This parameter defines the temperature change by which the actual temperature value must change so that the value is automatically sent out via the object. Setting to "0" at this point will deactivate the automatic transmission of the actual temperature. After bus voltage return or after an ETS programming operation, the object value is updated after a few seconds according to the current actual temperature value and transmitted to the KNX. The set "Delay after bus voltage return" is taken into account. | |
| Cyclical transmission (0...255 minutes) | 0...15...255 |
| This parameter determines whether and with what time the determined actual temperature is sent out cyclically on the KNX. | |

9.9.2 Temperature measurement objects

| Object no. | Function | Name | Type | DPT | Flag |
|------------|--------------------|--|---------|-------|---------------|
| 701 | Actual-temperature | Temperature measurement (...) - Output | 2 bytes | 9,001 | C, R, -, T, A |

2-byte object for the display of the determined actual temperature. The actual temperature is determined either by the internal sensor and optionally additionally by a temperature value received from the KNX. The output temperature value takes the configured value for calibration into account, as well as the measured value formation between the temperature values.

| Object no. | Function | Name | Type | DPT | Flag |
|------------|-----------------|--------------------------------------|---------|-------|-----------------|
| 702 | External sensor | Temperature measurement(...) - Input | 2 bytes | 9,001 | C, (R), W, -, A |

2-byte object for coupling an external KNX temperature sensor. This allows cascading of several temperature sensors for temperature measurement.

9.10 Disabling functions

Introduction

The device offers the option of blocking the inputs when they are used for buttons, switches and contacts or for leakage and dew sensors. It is then possible to deactivate all inputs or only a selection via the 1-bit communication object "Disabling". If the input is blocked, status changes of the connected controls or sensors are no longer evaluated. During a lockout, the inputs cannot perform any function or can temporarily perform another function.

i The locking function does not affect the temperature measurement of input 3.

The disabling function and the associated parameters and communication objects are enabled if the "Disabling function for inputs" parameter on the "General -> General inputs" parameter page is enabled.

i The locking function for the inputs cannot be used if the inputs act internally on the relay outputs of the device. In this case, the locking function of the outputs can be used.

The polarity of the disabling object can be set. In case of polarity inversion ("0 = disabled / 1 = enabled"), the disabling function is not activated immediately after bus voltage return or ETS programming. A "0" telegram must first be written to the disabling object to activate the locking function.

Repeated telegrams ("0" after "0" or "1" after "1") to the "Disabling" object show no reaction.

Defining the disabling function

- On the parameter page "General -> General inputs", activate the parameter "Disabling function for inputs". This parameter cannot be activated if the inputs act internally on the relay outputs of the device!

The "Disabling" communication object and the "Disabling function" parameter page are displayed.

- Set the polarity of the disabling object on the "Disabling function" parameter page.
- Assign the inputs to the disabling function. To do this, select those inputs that are to be affected by the disabling function with the parameter "Assignment of inputs". For "individual inputs assigned", make the assignment via the parameters "Input 1", "Input 2" and "Input 3". If an NTC temperature sensor is connected to input 3, the disabling function does not act on this input despite assignment!

Configuring the reaction at the beginning and end of a disable

If the disabling function is used, the reaction of the assigned inputs when activating and deactivating the locking can be set in the parameterisation.

The disabling function must be enabled.

- Set parameter "At the beginning of the disabling function" / "At the end of the disabling function" to "no reaction".
 The assigned inputs show no reaction at the beginning or end of the disabling. Only the behaviour "While active disabling function" is executed.
- Set parameter "At the beginning of the disabling function" / "At the end of the disabling function" to "as input ... when closing the contact" or "as input ... when opening the contact".
 The assigned inputs perform the function that the specified input has in the unlocked state. Fixed inputs are any inputs of the device with the function "switch, push button or contacts".

The respective parameterisation of the defined input is executed. If the parameterisation of this input has no function or no telegram when closing or opening, there is also no reaction to the disabling or to the enabling. The telegrams are sent out on the KNX via the communication object of the defined input.

The following table shows all possible telegram reactions of the device depending on the configured function of the set inputs.

| Function of the specified input | Reaction "as input ... when closing" | Reaction "as input ... when opening" |
|--|--------------------------------------|--------------------------------------|
| Switching / toggling | Switching telegram | Switching telegram |
| Dimming | Switching telegram | No telegram |
| Venetian blind | Long time telegram | No telegram |
| Scene extension | Scene recall telegram | No telegram |
| 1-byte value transmitter | Value telegram | No telegram |
| 2-byte value transmitter | Value telegram | No telegram |
| 3-byte value transmitter | Value telegram(s) | No telegram |
| 6-byte value transmitter | Value telegram(s) | No telegram |
| 2-channel operation Channel 1: 1-bit object type | Switching telegram | No telegram |
| 2-channel operation Channel 1: 1-byte object type | Value telegram | No telegram |
| 2-channel operation Channel 1: 2-byte object type | Value telegram | No telegram |
| 2-channel operation Channel 1: 3-byte object type | Value telegram(s) | No telegram |
| 2-channel operation Channel 1: 6-byte object type | Value telegram(s) | No telegram |
| Controller extension Operating mode switchover | Operating mode telegram | No telegram |

| Function of the specified input | Reaction "as input ... when closing" | Reaction "as input ... when opening" |
|---|--------------------------------------|--------------------------------------|
| Controller extension Presence function | Presence telegram | No telegram |
| Controller operation Setpoint shift | Level value telegram | No telegram |
| No function | No telegram | No telegram |

Table 4: Telegram reactions of the device depending on the configured function of the set inputs

- Set parameter "At the beginning of the disabling function" / "At the end of the disabling function" to "as disabling function ... when closing the contact" or "as disabling function ... when opening the contact".

The assigned inputs perform the function that has one of the two virtual disabling functions. The disabling functions are internal input functions with independent communication objects and independent parameters. The same setting options are available for disabling function 1 and disabling function 2 as for the normal inputs.

The respective configuration of the predefined disabling function will be executed. If the parameterisation of this disabling functions has no function or no telegram when closing or opening, there is also no reaction to the disabling or to the enabling.

The table shows all possible telegram reactions of the device depending on the project design of the disabling function for this setting, too. The telegrams are transmitted to the KNX via the communication object of the disabling function.

Configuring the reaction during a disable

Regardless of the behaviour that the assigned inputs show at the beginning or end of a disabling, the inputs can be influenced separately during a disabling.

The disabling function must be enabled.

- Set the parameter "While active disabling function" to "no reaction to signal changes at the input".

The assigned inputs are completely blocked during a disabling. Closing or opening a contact shows no reaction.

- Set the parameter to "Inputs behave like". Continue to configure the parameters "Input ... behaves like" to the desired input or the desired disabling function.

All assigned inputs behave as defined by the parameterisation of the specified reference inputs or disabling functions. Different but also the same reference inputs can be parameterised for the inputs. The two virtual disabling functions can also be selected as reference inputs.

The telegrams are transmitted to the KNX via the communication objects of the specified reference inputs.

- i** If, at the time of activation or deactivation of a disabling, a signal evaluation is taking place at the affected inputs of the device, this will be terminated immediately.

9.10.1 Disabling functions parameters

General... -> General inputs

| | |
|---|---------------------|
| Disabling function for inputs | Checkbox (yes / no) |
| <p>The disabling function can be enabled centrally at this point.</p> <p>The locking function for the inputs cannot be used if the inputs act internally on the relay outputs of the device. In this case, the locking function of the outputs can be used.</p> | |

Disabling function -> Disabling function

| | |
|--|--|
| Polarity of disabling object | 1 = disable / 0 = enable 0 = disable / 1 = enable |
| <p>This parameter defines the value of the disabling object at which the disabling function is active.</p> | |

| | |
|--|--|
| Assignment of inputs | all inputs assigned individual inputs assigned |
| <p>The disabling function affects either all inputs or only a selection. This parameter assigns the inputs to the disabling function.</p> <p>If an NTC temperature sensor is connected to input 3, the disabling function does not act on this input despite assignment!</p> | |

| | |
|---|---------------------|
| Input 1 | Checkbox (yes / no) |
| <p>With the setting "individual inputs assigned", this parameter defines the assignment of the first input to the disabling function.</p> | |

| | |
|--|---------------------|
| Input 2 | Checkbox (yes / no) |
| <p>With the setting "individual inputs assigned", this parameter defines the assignment of the second input to the disabling function.</p> | |

| | |
|--|---------------------|
| Input 3 | Checkbox (yes / no) |
| <p>With the setting "individual inputs assigned", this parameter defines the assignment of the third input to the disabling function.</p> <p>If an NTC temperature sensor is connected to input 3, the disabling function does not act on this input despite assignment!</p> | |

| | |
|---|---|
| <p>At the beginning of the disabling function</p> | <p>no reaction</p> <p>as input 1 when closing the contact</p> <p>as input 2 when closing the contact</p> <p>as input 3 when closing the contact</p> <p>as input 1 when opening the contact</p> <p>as input 2 when opening the contact</p> <p>as input 3 when opening the contact</p> <p>as disabling function 1 when closing the contact</p> <p>as disabling function 2 when closing the contact</p> <p>as disabling function 1 when opening the contact</p> <p>as disabling function 2 when opening the contact</p> |
|---|---|

If the lock function is used, the reaction of the assigned inputs when the disabling is activated can be set at this point.

| | |
|--|--|
| <p>While active disabling function</p> | <p>no reaction to signal changes at the input</p> <p>Inputs behave like</p> |
|--|--|

Regardless of the behaviour that the assigned inputs show at the beginning or end of a disabling, the inputs can be influenced separately during a disabling.

No reaction to signal changes at the input: The assigned inputs are completely blocked during a block. Closing or opening a contact shows no reaction.

Inputs behave like: All assigned inputs behave as defined by the parameterisation of the specified reference inputs or disabling functions. Different but also the same reference inputs can be parameterised for the inputs. The two virtual disabling functions can also be selected as reference inputs.

The telegrams are transmitted to the KNX via the communication objects of the specified reference inputs.

| | |
|-------------------------------|---|
| <p>Input ... behaves like</p> | <p>Input 1*</p> <p>Input 2*</p> <p>Input 3*</p> <p>Disabling function 1</p> <p>Disabling function 2</p> |
|-------------------------------|---|

The reference input or the disabling function is defined at this point. The disabled inputs then behave like the reference inputs or virtual disabling functions set at this point.

*: The default setting depends on the parameter for input 1, 2 or 3.

This parameter is only visible with "While active disabling function = Inputs behave like".

| | |
|---|--|
| At the end of the disabling function | no reaction as input 1 when closing the contact as input 2 when closing the contact as input 3 when closing the contact as input 1 when opening the contact as input 2 when opening the contact as input 3 when opening the contact as disabling function 1 when closing the contact as disabling function 2 when closing the contact as disabling function 1 when opening the contact as disabling function 2 when opening the contact |
| If the lock function is used, the reaction of the assigned inputs when the disabling is deactivated can be set at this point. | |

Disabling function 1 and disabling function 2

Disabling function -> Disabling function 1

Disabling function -> Disabling function 2

- i** The same parameters are available for the two virtual disabling functions as for the normal inputs.

9.10.2 Disabling functions objects

| Object no. | Function | Name | Type | DPT | Flag |
|------------|-----------|----------------------------|-------|-------|---------------|
| 758 | Disabling | Disabling function - input | 1-bit | 1,002 | C, -, W, -, - |

1-bit object for activating and deactivating the disabling function for the inputs. The polarity can be configured.

The two virtual disabling functions each have separate communication objects. The scope of all available objects is the same as for the normal input functions (see documentation of the input functions).

10 Logic functions

The device contains up to 8 logic functions. Simple or complex logical operations in a KNX installation can be performed using these functions. Linking of input and output objects allows the networking of logic functions, permitting the execution of complex operations.

Enabling and configuring the number of logic functions

To be able to use logic functions, they must be enabled centrally on the "General" parameter page.

- Activate the parameter "Logic functions"
The logic functions can be used. The "Logic functions" parameter node becomes available, which contains additional parameter pages. The configuration of the logic functions takes place in this parameter node.

Logic functions can be enabled in steps so that the number of visible functions and, in consequence, the available parameters and communication objects are visible in the ETS. The number of available logic functions can be defined on the "Logic functions" parameter page

- Configure the "Number of logic functions" parameter to the desired value.
As many logic functions are created as have been selected.
- i** The application program deletes existing logic functions from the configuration if the number of available functions is reduced.

Up to two time functions can be preset for each switching output, independently of each other. The time functions affect the communication objects "Switching" and delay the object value received depending on the telegram polarity .

- i** At the end of a disabling function, the switching state received during the function or set before the function can be tracked. At the same time, residual times of time functions are also tracked if these had not yet fully elapsed at the time of the reactivation.
- i** The time delays do not influence the staircase function if this is enabled.
- i** A time delay still in progress will be fully aborted by a reset of the actuator (bus voltage failure or ETS programming).

10.1 Logic functions parameters

General

| Logic functions | Checkbox (yes / no) |
|---|---------------------|
| This parameter enables the logic functions globally. If the parameter is activated, the "Logic functions" parameter node becomes available, which contains additional parameter pages. The configuration of the logic functions takes place in this parameter node. | |

| Number of logic functions (1...8) | 1...8 |
|---|-------|
| The number of required logic functions is defined here. | |

Logic functions -> Logic function...

| Name of logic function | Free text |
|--|-----------|
| The text entered in this parameter is applied to the name of the communication objects and is used to label the logic function in the ETS parameter window (e. g. "limit value switch outside temperature", disabling of Venetian blind garden door). The text is not programmed in the device. | |

| | |
|---|---|
| <p>Type of logic function</p> | <p>Logic gates Converter (1 bit -> 1 byte) Disabling element [Filtering/Time] Comparator Limit value switch with hysteresis</p> |
| <p>It is possible to be define which logical operation is to be executed for each logic function. This parameter is only visible if the logic functions have been enabled on the "General" parameter page.</p> <p>Logic gates: The logic function works as a Boolean logic gate with optionally 1 ... 4 inputs and one output.</p> <p>Converter (1 bit -> 1 byte): The logic function is configured as a converter. The converter has a 1-bit input and a 1-byte output and also a disabling object. ON / OFF telegrams can be converted to preconfigured values. The disabling object is able to deactivate the converter</p> <p>Disabling element (Filtering/Time): The logic function is configured as a disabling element. The disabling element has a 1-bit input and a 1-bit output. This logic function can delay input signals depending on the state (ON or OFF) and output them filtered at the output. A disabling object is also available, which can be used to deactivate the disabling element.</p> <p>Comparator: The logic function works as a comparator with an input whose data format can be parameterised, and with a 1-bit output to output the result of the comparison operation. The reference function and the reference value are configured in the ETS.</p> <p>Limit value switch with hysteresis: The logic function acts like a limit switch with hysteresis. An input with a configurable data format and a 1-bit output are available. The hysteresis is determined by an upper and lower threshold. The threshold values can be parameterised in the ETS. The input value is compared with the threshold values. The command at the output (ON / OFF) upon exceeding or falling below the configured threshold values can be configured.</p> | |

10.2 Logic gates

A logic gate has up to 4 Boolean inputs (1 bit) and one logic output (1 bit). In consequence, a logic operation only supports the 1-bit data format. The following table shows configurable comparison operations Logic gate and explains their function.

| Logic gates | Description | Icon |
|------------------------------|--|------|
| Invert (NOT) | The logic gate has only one input. The input is forwarded to the gate output inverted. | |
| AND (AND) | Logic gate has 4 inputs The output is "1" if all inputs are "1". Otherwise the output is "0". | |
| OR (OR) | Logic gate has 4 inputs The output is "0" if all inputs are "0". Otherwise the output is "1". | |
| Exclusive OR (XOR) | Logic gate has 4 inputs The output is "1" if only one input is "1". Otherwise the output is "0". | |
| inverted AND (NAND) | Logic gate has 4 inputs The output is "0" if all inputs are "1". Otherwise the output is "1". | |
| inverted OR (NOR) | Logic gate has 4 inputs The output is "1" if all inputs are "0". Otherwise the output is "0". | |
| inverted Exclusive OR (NXOR) | Logic gate has 4 inputs The output is "0" if only one input is "1". Otherwise the output is "1". | |
| AND with feedback (ANDR) | Logic gate has 4 inputs The output is fed back to the first input of the gate. The output is "1" if all inputs are "1". Otherwise the output is "0". If input 1 is set to "1" and the output is still "0", the feedback of input 1 is also reset to "0". Only when | |

| Logic gates | Description | Icon |
|-------------|--|------|
| | <p>inputs 2 ... 4 are "1" will a newly received "1" at input 1 cause the output to assume the logical state "1".</p> <p>Application: Switch light manually only at twilight -> Switch on input 1, twilight sensor on input 2 -> The manual switching signal is ignored for as long as the twilight sensor has not issued an enabling signal. The manual switching sign is only executed at twilight.</p> | |

Inputs of a logic gate can be activated or deactivated separately. This allows gates with an individual number of inputs (1 ... 4) to be implemented. As an option, it is possible to invert inputs.

The transmission behaviour of the gate output can be configured.

10.2.1 Logic gate parameters

Logic functions -> Logic function...

| | |
|--|---|
| Selection logic gate | Invert (NOT) AND (AND) OR (OR) Exclusive OR (XOR) inverted AND (NAND) inverted OR (NOR) inverted Exclusive OR (NXOR) AND with feedback (ANDR) |
| <p>This parameter defines the function of the logic gate and is only visible if "Type of logic function = logic gate".</p> <p>Invert (NOT): The inverter is configured. The gate has one input and one output. The Boolean data value of the input is forwarded to the output inverted.</p> <p>And (AND): An AND gate is configured. The gate has 1...4 inputs and one output. The inputs are logically AND-linked. The result is forwarded to the output.</p> <p>Or (OR): An OR gate is configured. The gate has 1...4 inputs and one output. The inputs are logically OR-linked. The result is forwarded to the output.</p> <p>Exclusive-OR (XOR): An exclusive-OR gate is configured. The gate has 1...4 inputs and one output. The inputs are logically Exclusive-OR-linked. The result is forwarded to the output.</p> <p>inverted And (NAND): An AND gate is configured. The gate has 1...4 inputs and one output. The inputs are logically AND-linked. The result is forwarded to the output inverted.</p> <p>inverted OR (NOR): An OR gate is configured. The gate has 1...4 inputs and one output. The inputs are logically OR-linked. The result is forwarded to the output inverted.</p> <p>Inverted Exclusive-OR (NXOR): An inverted Exclusive-OR gate is configured. The gate has 1...4 inputs and one output. The inputs are logically Exclusive-OR-linked. The result is forwarded to the output inverted.</p> <p>AND with feedback (ANDR): An AND gate with feedback is configured. The gate has 1...4 inputs and one output. The output is fed back to the first input of the gate.</p> | |
| Input 1 | deactivated input object |
| <p>Inputs of a logic gate can be activated or deactivated separately. This allows gates with an individual number of inputs (1 ... 4) to be implemented. This parameter defines whether the first input of the gate should be used.</p> <p>This parameter is only visible if "Type of logic function = logic gate".</p> | |

| | |
|---|---|
| Input 2 | deactivated input object |
| <p>Inputs of a logic gate can be activated or deactivated separately. This allows gates with an individual number of inputs (1 ... 4) to be implemented. This parameter defines whether the second input of the gate should be used.</p> <p>This parameter is only visible if "Type of logic function = logic gate".</p> | |
| Input 3 | deactivated input object |
| <p>Inputs of a logic gate can be activated or deactivated separately. This allows gates with an individual number of inputs (1 ... 4) to be implemented. This parameter defines whether the third input of the gate should be used.</p> <p>This parameter is only visible if "Type of logic function = logic gate".</p> | |
| Input 4 | deactivated input object |
| <p>Inputs of a logic gate can be activated or deactivated separately. This allows gates with an individual number of inputs (1 ... 4) to be implemented. This parameter defines whether the fourth input of the gate should be used.</p> <p>This parameter is only visible if "Type of logic function = logic gate".</p> | |
| Invert input | Checkbox (yes / no) |
| <p>It is possible to invert inputs of the logic gate as an option. This parameter is available for each input of the gate and defines whether the respective input should be evaluated unchanged or inverted.</p> <p>This parameter is only visible if "Type of logic function = logic gate".</p> | |
| Transmission criteria | always transmit when the input is updated send only if the output changes transmit cyclically |
| <p>The transmission behaviour of the output can be configured here.</p> <p>Always transmit when the input is updated: The output transmits the current object value to the KNX with every telegram that is received at the input.</p> <p>Transmit only if the output changes: The output only transmits the current object value if the object value has changed compared to the last transmission process. During the first telegram to an input after bus voltage return or after an ETS programming operation, the output always transmits to an input.</p> <p>transmit cyclically: With this setting, the output transmits the current object value to the KNX cyclically. The cyclical transmission is only started by the first valid trigger after the first telegram has been received at the input. The output also transmits as soon as a new telegram is received at the input. At the same time, the cycle time for cyclical sending is restarted!</p> | |

| | |
|--|------------|
| Transmission delay for sending the result hours (0...99) | 0...99 |
| <p>An optional delay before result transmission (telegram at output) can be configured. With the setting "always transmit when the input is updated": Telegrams at the output are only transmitted after the trigger when the delay has elapsed. The delay time is restarted by each telegram at the input.</p> <p>With the setting "only transmit if the output changes": Telegrams are only sent when the object value changes at the output if the delay has expired. If the logic function is reprocessed by a new telegram at the input within the delay time and the object value changes again, then the delay restarts. If the object value of the output does not change due to new input telegrams, the delay does not restart.</p> <p>This parameter defines the hours of the delay time.</p> | |
| Minutes (0...59) | 0...59 |
| <p>This parameter defines the minutes of the delay time.</p> | |
| Seconds (0...59) | 0...59 |
| <p>This parameter defines the seconds of the delay time.</p> <p>The parameters for the transmission delay are only visible for "Transmission criteria" = "Always transmit when the input is updated" and "Only transmit when the output changes".</p> | |
| Cycle time hours (0...99) | 0...99 |
| <p>During cyclical transmission of the output, this parameter defines the cycle time. Setting the cycle time hours.</p> | |
| Minutes (0...59) | 0...5...59 |
| <p>This parameter defines the minutes of the cycle time.</p> | |
| Seconds (0...59) | 0...59 |
| <p>This parameter defines the seconds of the cycle time.</p> <p>The parameters for the cycle time are only visible if "transmission criteria" = "transmit cyclically".</p> | |

10.2.2 Logic gate objects

| Object no. | Function | Name | Type | DPT | Flag |
|---|--------------------------|------------------|-------|-------|--------------------|
| 295, 299, 303, 307, 311, 315, 319, 323 | Logic gate... Input 1 | Logic... - Input | 1-bit | 1,002 | C, (R), W, -, A |
| <p>1-bit object as input 1 of a logic gate (1...8). The input status can be inverted optionally.</p> <p>This object is only available if the type of logic function is configured to "logic gate" and input 1 is used..</p> | | | | | |

| Object no. | Function | Name | Type | DPT | Flag |
|---|--------------------------|------------------|-------|-------|--------------------|
| 296, 300. 304, 308, 312, 316, 320, 324 | Logic gate... Input 2 | Logic... - Input | 1-bit | 1,002 | C, (R), W, -, A |
| <p>1-bit object as input 2 of a logic gate (1...8). The input status can be inverted optionally.</p> <p>This object is only available if the type of logic function is configured to "logic gate" and input 2 is used..</p> | | | | | |

| Object no. | Function | Name | Type | DPT | Flag |
|---|--------------------------|------------------|-------|-------|--------------------|
| 297, 301. 305, 309, 313, 317, 321, 325 | Logic gate... Input 3 | Logic... - Input | 1-bit | 1,002 | C, (R), W, -, A |
| <p>1-bit object as input 3 of a logic gate (1...8). The input status can be inverted optionally.</p> <p>This object is only available if the type of logic function is configured to "logic gate" and input 3 is used..</p> | | | | | |

| Object no. | Function | Name | Type | DPT | Flag |
|---|--------------------------|------------------|-------|-------|--------------------|
| 298, 302. 306, 310, 314, 318, 322, 326 | Logic gate... Input 4 | Logic... - Input | 1-bit | 1,002 | C, (R), W, -, A |
| <p>1-bit object as input 4 of a logic gate (1...8). The input status can be inverted optionally.</p> <p>This object is only available if the type of logic function is configured to "logic gate" and input 4 is used..</p> | | | | | |

| Object no. | Function | Name | Type | DPT | Flag |
|--|-------------------|-------------------|-------|-------|---------------|
| 383, 385, 387, 389, 391, 393, 395, 397 | Logic gate output | Logic... - Output | 1-bit | 1,002 | C, R, -, T, A |
| <p>1-bit object as output of a logic gate (1...8).</p> <p>This object is only available if the type of logic function is configured to "logic gate".</p> | | | | | |

10.3 Converter (1 bit -> 1 byte)

The converter has a 1-bit input and a 1-byte output and also a disabling object. ON / OFF telegrams can be converted to preconfigured values. The disabling object is able to deactivate the converter

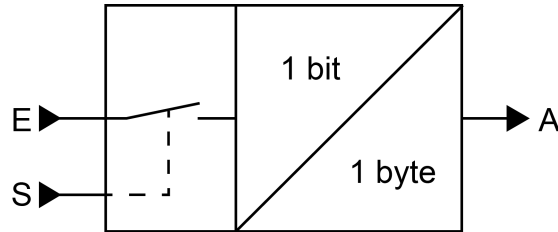

Image 26: Converter (1 bit -> 1 byte)

The converter can react differently to input states. The parameter "Reaction at input to" defines whether the converter responds to ON and OFF commands or alternatively only processes ON or OFF telegrams.

A concrete 1-byte output value can be assigned to each 1-bit input status. The two output values can be configured anywhere in the range 0 ... 255 as required. The data format of the converter output object is set to DPT 5.001 (0...100%).

The disabling object can be deactivated via the converter. A deactivated converter no longer processes input states and consequently does not convert any new output values (the last value is retained and transmitted cyclically, if necessary). At the end of a disabling function, the converter is enabled again. The converter then waits for the next telegram at the input.

The telegram polarity of the disabling object can be configured.

The transmission behaviour of the converter output can be configured.

10.3.1 Converter parameters

Logic functions -> Logic function...

| | |
|---|--|
| Reaction at input to | ON and OFF telegrams ON telegrams OFF telegrams |
| The converter can react differently to input states. It is defined here whether the converter responds to ON and OFF commands or alternatively only processes ON or OFF telegrams. | |
| Polarity of the disabling object | 0 = enabled / 1 = disabled 0 =disabled/ 1 = enabled |
| This parameter defines the polarity of the disabling object. | |
| Output value for ON (0...255) | 0...255 |
| A concrete 1-byte output value can be assigned to each 1-bit input status. This parameter defines the output value for ON telegrams. This parameter is only visible when the input should react to ON telegrams. | |
| Output value for OFF (0...255) | 0...255 |
| A concrete 1-byte output value can be assigned to each 1-bit input status. This parameter defines the output value for OFF telegrams. This parameter is only visible when the input should react to OFF telegrams. | |
| Transmission criteria | always transmit when the input is updated send only if the output changes transmit cyclically |
| The transmission behaviour of the output can be configured here. Always transmit when the input is updated: The output transmits the current object value to the KNX with every telegram that is received at the input. Transmit only if the output changes: The output only transmits the current object value if the object value has changed compared to the last transmission process. During the first telegram to an input after bus voltage return or after an ETS programming operation, the output always transmits to an input. transmit cyclically: With this setting, the output transmits the current object value to the KNX cyclically. The cyclical transmission is only started by the first valid trigger after the first telegram has been received at the input. The output also transmits as soon as a new telegram is received at the input. At the same time, the cycle time for cyclical sending is restarted! | |

| | |
|--|------------|
| Transmission delay for sending the result hours (0...99) | 0...99 |
| <p>An optional delay before result transmission (telegram at output) can be configured. With the setting "always transmit when the input is updated": Telegrams at the output are only transmitted after the trigger when the delay has elapsed. The delay time is restarted by each telegram at the input.</p> <p>With the setting "only transmit if the output changes": Telegrams are only sent when the object value changes at the output if the delay has expired. If the logic function is reprocessed by a new telegram at the input within the delay time and the object value changes again, then the delay restarts. If the object value of the output does not change due to new input telegrams, the delay does not restart.</p> <p>This parameter defines the hours of the delay time.</p> | |
| Minutes (0...59) | 0...59 |
| <p>This parameter defines the minutes of the delay time.</p> | |
| Seconds (0...59) | 0...59 |
| <p>This parameter defines the seconds of the delay time.</p> <p>The parameters for the transmission delay are only visible for "Transmission criteria" = "Always transmit when the input is updated" and "Only transmit when the output changes".</p> | |
| Cycle time hours (0...99) | 0...99 |
| <p>During cyclical transmission of the output, this parameter defines the cycle time. Setting the cycle time hours.</p> | |
| Minutes (0...59) | 0...5...59 |
| <p>This parameter defines the minutes of the cycle time.</p> | |
| Seconds (0...59) | 0...59 |
| <p>This parameter defines the seconds of the cycle time.</p> <p>The parameters for the cycle time are only visible if "transmission criteria" = "transmit cyclically".</p> | |

10.3.2 Converter objects

| Object no. | Function | Name | Type | DPT | Flag |
|---|-----------------|------------------|-------|-------|--------------------|
| 295, 299, 303, 307, 311, 315, 319, 323 | Converter Input | Logic... - Input | 1-bit | 1,002 | C, (R), W, -, A |

1-bit object as input of a converter. It is possible to configure whether the converter responds to ON and OFF commands or alternatively only processes ON or OFF telegrams.

This object is only available if the type of logic function is configured to "converter".

| Object no. | Function | Name | Type | DPT | Flag |
|---|---------------------------------|------------------|-------|-------|--------------------|
| 296, 300, 304, 308, 312, 316, 320, 324 | Converter Disabling function | Logic... - Input | 1-bit | 1,002 | C, (R), W, -, A |

1-bit object as disabling input of a converter. A disabled converter no longer processes input states and consequently does not convert any new output values (the last value is retained and transmitted cyclically, if necessary).

The telegram polarity can be configured.

This object is only available if the type of logic function is configured to "converter".

| Object no. | Function | Name | Type | DPT | Flag |
|---|------------------|-------------------|---------|-------|---------------|
| 431, 432, 433, 434, 435, 436, 437, 438 | Converter Output | Logic... - Output | 1 bytes | 5,001 | C, R, -, T, A |

1-byte object as value output of a converter.

This object is only available if the type of logic function is configured to "converter".

10.4 Disabling element [Filtering/Time]

The disabling element has a 1-bit input and a 1-bit output as well as a disabling object. Input states (ON/OFF) can be delayed independently of one another and filtered at the output before output. The filter makes it possible to invert the states of the output (e.g. ON -> OFF) or to suppress it completely (e.g. OFF -> ---, OFF is not transmitted). If the filter is not used, the disabling element only works with the time functions if required. Alternatively, it is possible to use only the filter (without delays).

The disabling object is able to deactivate the disabling element.

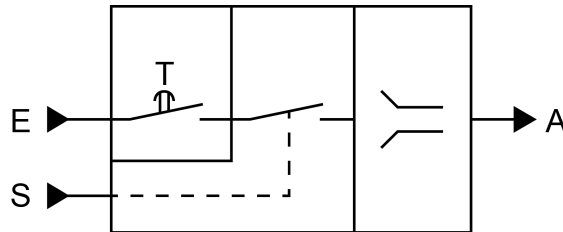

Image 27: Disabling element [Filtering/Time]

The parameter "Time function" defines whether ON or OFF telegrams or both states are evaluated with a delay after reception at the input. If a delay is provided, the delay time can be configured separately for ON and OFF telegrams. A delay is only effective if the delay time is set to greater than "0". Each telegram received at the input re-triggers the receptive delay time.

If no delay is configured, the input telegrams go directly into the filter.

i Special feature when using the delays: If no telegram is received at the input, a configured delay time (time > 0) acts like an automatic cyclic trigger of the filter. The most recently received input status is then forwarded to the filter automatically and repeatedly after the delay has elapsed. This then works according to its configuration and forwards the result to the output of the disabling element. Consequently, the output then also transmits telegrams depending on the transmission criteria set. If the cyclical transmission of the output is not desired due to the automatic triggering of the filter, the transmission criterion should be set to "only transmit if the output changes".

If no delay is provided, the filter is only triggered automatically via the received telegrams and thus not automatically.

i After bus voltage return or after an ETS programming operation, the delays are triggered automatically.

The filter is set by the parameter "Filter function" according to the following table.

| Filter function | Result |
|------------------------|---|
| ON -> OFF / OFF -> OFF | Input telegrams are forwarded to the output unchanged. Filter deactivated. |
| ON -> --- / OFF -> OFF | ON telegrams are filtered and not forwarded to the output. OFF telegrams are forwarded to the output unchanged. |

| Filter function | Result |
|------------------------|--|
| ON -> ON / OFF -> --- | OFF telegrams are filtered and not forwarded to the output. ON telegrams are forwarded to the output unchanged. |
| ON -> OFF / OFF -> ON | ON telegrams are converted to OFF telegrams and OFF telegrams are converted to ON telegrams and are forwarded to the output. |
| ON -> --- / OFF -> ON | ON telegrams are filtered and not forwarded to the output. OFF telegrams are converted to ON telegrams and forwarded to the output. |
| ON -> OFF / OFF -> --- | OFF telegrams are filtered and not forwarded to the output. ON telegrams are converted to OFF telegrams and forwarded to the output. |

The disabling element can be deactivated by the disabling object. A deactivated disabling element no longer forwards any input states to the filter and consequently does not convert any new output values (the last value is retained and transmitted cyclically, if necessary). However, the input states are still evaluated (even with effective delays). At the end of a disabling function, the disabling element is enabled again. The disabling element waits for the next telegram at the input or for the next cycle of the configured delay times.

The telegram polarity of the disabling object can be configured.

The transmission behaviour of the disabling element output can be configured.

10.4.1 Disabling element parameters

Logic functions -> Logic function...

| | |
|---|--|
| Time function | no delay only delay ON telegrams only delay OFF telegrams delay ON and OFF telegrams |
| This parameter defines whether ON or OFF telegrams or both states are evaluated with a delay after reception at the input. If a delay is provided, the delay time can be configured separately for ON and OFF telegrams. If no delay is configured, the input telegrams go directly into the filter. | |
| Delay for ON telegrams Minutes (0...59) | 0...59 |
| <p>The delay for ON telegrams is configured here. A delay is only effective if the delay time is set to greater than "0". Each ON telegram received at the input re-triggers the delay time.</p> <p>Special feature when using the delays: If no telegram is received at the input, a configured delay time (time > 0) acts like an automatic cyclic trigger of the filter. The most recently received input status is then forwarded to the filter automatically and repeatedly after the delay has elapsed. This then works according to its configuration and forwards the result to the output of the disabling element. Consequently, the output then also transmits telegrams depending on the transmission criteria set. If the cyclical transmission of the output is not desired due to the automatic triggering of the filter, the transmission criterion should be set to "only transmit if the output changes".</p> <p>After bus voltage return or after an ETS programming operation, the delays are triggered automatically.</p> <p>Setting the ON delay time minutes.</p> | |
| Seconds (0...59) | 0...10...59 |
| Setting the seconds of the ON delay time. The parameters for the ON delay are only available if the parameter "Time function" is set to "only delay ON telegrams" or "delay ON and OFF telegrams". | |

| | |
|--|---|
| Delay for OFF telegrams Minutes (0...59) | 0...59 |
| <p>The delay for OFF telegrams is configured here. A delay is only effective if the delay time is set to greater than "0". Each OFF telegram received at the input re-triggers the delay time.</p> <p>Special feature when using the delays: If no telegram is received at the input, a configured delay time (time > 0) acts like an automatic cyclic trigger of the filter. The most recently received input status is then forwarded to the filter automatically and repeatedly after the delay has elapsed. This then works according to its configuration and forwards the result to the output of the disabling element. Consequently, the output then also transmits telegrams depending on the transmission criteria set. If the cyclical transmission of the output is not desired due to the automatic triggering of the filter, the transmission criterion should be set to "only transmit if the output changes".</p> <p>After bus voltage return or after an ETS programming operation, the delays are triggered automatically.</p> <p>Setting the OFF delay time minutes.</p> | |
| Seconds (0...59) | 0...10...59 |
| <p>Setting the OFF delay time seconds.</p> <p>The parameters for the OFF delay are only available if the parameter "Time function" is set to "only delay OFF telegrams" or "delay ON and OFF telegrams".</p> | |
| Polarity of the disabling object | 0 = enabled / 1 = disabled 0 =disabled/ 1 = enabled |
| <p>This parameter defines the polarity of the disabling object.</p> | |

| | |
|-----------------|---|
| Filter function | ON -> OFF / OFF -> OFF ON -> --- / OFF -> OFF ON -> ON / OFF -> --- ON -> OFF / OFF -> ON ON -> --- / OFF -> ON ON -> OFF / OFF -> --- |
|-----------------|---|

This parameter defines the function of the filter.

ON -> ON / OFF -> OFF: Input telegrams are forwarded to the output unchanged. Filter deactivated.

ON -> --- / OFF -> OFF: ON telegrams are filtered and not forwarded to the output. OFF telegrams are forwarded to the output unchanged.

ON -> ON / OFF -> ---: OFF telegrams are filtered and not forwarded to the output. ON telegrams are forwarded to the output unchanged.

ON -> OFF / OFF -> ON: ON telegrams are converted to OFF telegrams and OFF telegrams are converted to ON telegrams and forwarded to the output.

ON -> --- / OFF -> ON: ON telegrams are filtered and not forwarded to the output. OFF telegrams are converted to ON telegrams and forwarded to the output.

ON -> OFF / OFF -> ---: OFF telegrams are filtered and not forwarded to the output. ON telegrams are converted to OFF telegrams and forwarded to the output.

| | |
|-----------------------|---|
| Transmission criteria | always transmit when the input is updated send only if the output changes transmit cyclically |
|-----------------------|---|

The transmission behaviour of the output can be configured here.

Always transmit when the input is updated: The output transmits the current object value to the KNX with every telegram that is received at the input. In addition, transmission at the output is repeated if no telegram was received at the input when the delay times were used and the configured time has expired.

Transmit only if the output changes: The output only transmits the current object value if the object value has changed compared to the last transmission process. After bus voltage return or an ETS programming operation, the output always transmits.

transmit cyclically: With this setting, the output transmits the current object value to the KNX cyclically. The cyclical transmission is only started by the first valid trigger after the first telegram has been received at the input. If the ON / OFF delay is used, after bus voltage return or after an ETS programming, operation cyclical transmission starts automatically once the delay time has expired. The output also transmits as soon as a new telegram is received at the input. At the same time, the cycle time for cyclical sending is restarted!

| | |
|---------------------------|--------|
| Cycle time hours (0...99) | 0...99 |
|---------------------------|--------|

During cyclical transmission of the output, this parameter defines the cycle time. Setting the cycle time hours.

| | |
|---|------------|
| Minutes (0...59) | 0...5...59 |
| This parameter defines the minutes of the cycle time. | |
| Seconds (0...59) | 0...59 |
| This parameter defines the seconds of the cycle time. The parameters for the cycle time are only visible if "transmission criteria" = "transmit cyclically". | |

10.4.2 Disabling element objects

| Object no. | Function | Name | Type | DPT | Flag |
|---|----------------------------|------------------|-------|-------|--------------------|
| 295, 299, 303, 307, 311, 315, 319, 323 | Disabling element Input | Logic... - Input | 1-bit | 1,002 | C, (R), W, -, A |
| <p>1-bit object as input of a disabling element.</p> <p>This object is only available if the type of logic function is configured to "disabling element".</p> | | | | | |

| Object no. | Function | Name | Type | DPT | Flag |
|---|---|------------------|-------|-------|--------------------|
| 296, 300. 304, 308, 312, 316, 320, 324 | Disabling element Disabling function | Logic... - Input | 1-bit | 1,002 | C, (R), W, -, A |
| <p>1-bit object as disabling input of a disabling element. A disabled disabling element no longer forwards any input states to the filter and consequently does not convert any new output values (the last value is retained and transmitted cyclically, if necessary).</p> <p>The telegram polarity can be configured.</p> <p>This object is only available if the type of logic function is configured to "disabling element".</p> | | | | | |

| Object no. | Function | Name | Type | DPT | Flag |
|--|-----------------------------|-------------------|-------|-------|---------------|
| 384, 386, 388, 390, 392, 394, 396, 398 | Disabling element Output | Logic... - Output | 1-bit | 1,002 | C, R, -, T, A |
| <p>1-bit object as output of a disabling element.</p> <p>This object is only available if the type of logic function is configured to "disabling element".</p> | | | | | |

10.5 Comparator

The comparator works with an input whose data format can be parameterised, and with a 1-bit output to output the result of the comparison operation. The comparator compares the value received at the input with a configured reference value and evaluates whether the reference is correct (result = true) or not (result = false) according to the specified reference function.

The reference function and the reference value are configured in the ETS.

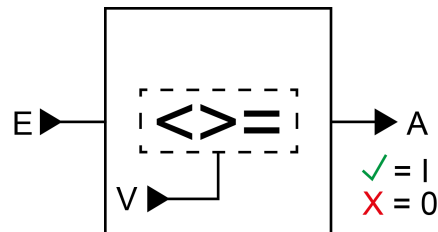

Image 28: Comparator

The parameter "data format" defines the size and format of input object according to the following table. The output object is preset to 1-bit (DPT 1.002) and outputs the result of the comparison operation (ON = true / OFF = false). The reference value that can be set in the ETS adapts to the input data format.

| Data format | KNX DPT |
|---------------------------------------|---------|
| 4-bit dimming | 3,007 |
| 1-byte operating mode switchover | 20,102 |
| 1- byte scene extension | 18,001 |
| 1-byte value 0...255 | 5,010 |
| 1-byte brightness value 0...100% | 5,001 |
| 2-byte value 0...65535 | 7,001 |
| 2-byte value -32768...32767 | 8,001 |
| 2-byte floating-point number | 9.0xx |
| 4-byte value -2147483648...2147483647 | 13,001 |

The following table shows the possible reference functions (I = input value, R = reference value).

| Reference function | Function |
|----------------------|--|
| equal (I = R) | The comparator output is "ON" (true) if the input is equal to the reference value. Otherwise the output is "OFF" (false). |
| unequal (I ≠ R) | The comparator output is "ON" (true) if the input is unequal to the reference value. If the input value is equal to the reference value, the output is "OFF" (false). |
| greater than (I > R) | The comparator output is "ON" (true) if the input is greater than the reference value. If the input value is less than or equal to the reference value, the output switches "OFF" (false). |

| Reference function | Function |
|---|--|
| greater than or equal to ($I \geq R$) | The comparator output is "ON" (true) if the input is greater than the reference value or equal to the reference value. If the input value is less than the reference value, the output switches "OFF" (false). |
| less than ($I < R$) | The comparator output is "ON" (true) if the input is less than the reference value. If the input value is greater than or equal to the reference value, the output switches "OFF" (false). |
| less than or equal to ($I \leq R$) | The comparator output is "ON" (true) if the input is less than the reference value or equal to the reference value. If the input value is greater than the reference value, the output switches "OFF" (false). |
| range testing less than ($R1 < I < R2$) | There are two reference values. The comparator output is "ON" (true) if the input is greater than the first reference value or less than the second reference value. If the input value is less than the first reference value or equal to the first reference value or greater than the second reference value or equal to the second reference value, the output switches "OFF" (wrong). |
| range testing less than or equal to ($R1 \leq I \leq R2$) | There are two reference values. The comparator output is "ON" (true) if the input is greater than or equal to the first reference value and less than or equal to the second reference value, the output switches "OFF" (false). If the input value is less than the first reference value or greater than the second reference value, the output switches "OFF" (false). |

The transmission behaviour of the comparator output can be configured.

10.5.1 Comparator parameters

Logic functions -> Logic function...

| | |
|--|--|
| Data format | 4-bit dimming (DPT 3.007) 1-byte operating mode switchover (DPT 20.102) 1-byte scene extension (DPT 18.001) 1-byte value 0...255 (DPT 5.010) 1-byte brightness value 0...100 % (DPT 5.001) 2-byte value 0...65535 (DPT 7.001) 2-byte value -32768...32767 (DPT 8.001) 2-byte floating-point number (DPT 9.0xx) 4-byte value -2147483648...2147483647 (DPT 13.001) |
| <p>This parameter defines the size and format of input object. The output object is pre-set to 1-bit (DPT 1.002) and outputs the result of the comparison operation (ON = true / OFF = false).</p> | |

| | |
|--------------------|--|
| Reference function | equal ($E = V$) unequal ($E \neq V$) greater than ($E > V$) greater than or equal to ($E \geq V$) less than ($E < V$) less than or equal to ($E \leq V$) range testing less than ($V1 < E < V2$) range testing smaller than or equal to ($V1 \leq E \leq V2$) |
|--------------------|--|

The comparator compares the value received (I) at the input with a configured reference value (R) and evaluates whether the comparison is correct (result = true) or not (result = false) according to the specified reference function here.

equal ($I = R$): The comparator output is "ON" (true) if the input is equal to the reference value. Otherwise the output is "OFF" (false).

unequal ($I \neq R$): The comparator output is "ON" (true) if the input is unequal to the reference value. If the input value is equal to the reference value, the output is "OFF" (false).

greater ($I > R$): The comparator output is "ON" (true) if the input is greater than the reference value. If the input value is less than or equal to the reference value, the output switches "OFF" (false).

greater than or equal to ($I \geq R$): The comparator output is "ON" (true) if the input is greater than the reference value or equal to the reference value. If the input value is less than the reference value, the output switches "OFF" (false).

less than ($I < R$): The comparator output is "ON" (true) if the input is less than the reference value. If the input value is greater than or equal to the reference value, the output switches "OFF" (false).

less than or equal to ($I \leq R$): The comparator output is "ON" (true) if the input is less than the reference value or equal to the reference value. If the input value is greater than the reference value, the output switches "OFF" (false).

Range testing less than ($R1 < I < R2$): There are two reference values. The comparator output is "ON" (true) if the input is greater than the first reference value or less than the second reference value. If the input value is less than the first reference value or equal to the first reference value or greater than the second reference value or equal to the second reference value, the output switches "OFF" (wrong).

Range testing less than or equal to ($R1 \leq I \leq R2$): There are two reference values. The comparator output is "ON" (true) if the input is greater than or equal to the first reference value and less than or equal to the second reference value, the output switches "OFF" (false). If the input value is less than the first reference value or greater than the second reference value, the output switches "OFF" (false).

| | |
|---------------------|--|
| Reference value (V) | <p>dimming darker, stop (0)</p> <p>dimming darker, 100 % (1)</p> <p>dimming darker, 50 % (2)</p> <p>dimming darker, 25 % (3)</p> <p>dimming darker, 12.5 % (4)</p> <p>dimming darker, 6 % (5)</p> <p>dimming darker, 3 % (6)</p> <p>dimming darker, 1.5 % (7)</p> <p>increase brightness, stop (8)</p> <p>increase brightness, 100 % (9)</p> <p>increase brightness, 50 % (10)</p> <p>increase brightness, 25 % (11)</p> <p>increase brightness, 12.5 % (12)</p> <p>increase brightness, 6 % (13)</p> <p>increase brightness, 3 % (14)</p> <p>increase brightness, 1.5 % (15)</p> |
|---------------------|--|

This parameter specifies the internal reference value (R) for the reference function.
 This parameter is only available if the "data format" is set to "4-bit dimming (DPT 3.007)".

| | |
|---------------------|---|
| Reference value (V) | <p>automatic (0)</p> <p>comfort mode (1)</p> <p>standby mode (2)</p> <p>night operation (3)</p> <p>frost/heat protection (4)</p> |
|---------------------|---|

This parameter specifies the internal reference value (R) for the reference function.
 This parameter is only available if the "data format" is set to "1 byte operating mode switchover (DPT 20.102)".

| | |
|---------------------|---|
| Reference value (V) | <p>recall scene 1 (0)</p> <p>recall scene 2 (1)</p> <p>...</p> <p>recall scene 64 (63)</p> <p>save scene 1 (128)</p> <p>save scene 2 (129)</p> <p>...</p> <p>save scene 64 (191)</p> |
|---------------------|---|

This parameter specifies the internal reference value (R) for the reference function.
 This parameter is only available if the "data format" is set to "1 byte scene extension (DPT 18.001)".

| | |
|---|------------------------------|
| Reference value (V) (0...255) | 0...255 |
| <p>This parameter specifies the internal reference value (R) for the reference function. This parameter is only available if the "data format" is set to "1 byte value -0...255 (DPT 5.010)".</p> | |
| Reference value (V) (0...100%) | 0...100 |
| <p>This parameter specifies the internal reference value (R) for the reference function. This parameter is only available if the "data format" is set to "1 byte brightness value 0...100 % (DPT 5.001)".</p> | |
| Reference value (V) (0...65535) | 0...65535 |
| <p>This parameter specifies the internal reference value (R) for the reference function. This parameter is only available if the "data format" is set to "2 byte value 0...65535 (DPT 7.001)".</p> | |
| Reference value (V) (-32768...32767) | -32768...0...32767 |
| <p>This parameter specifies the internal reference value (R) for the reference function. This parameter is only available if the "data format" is set to "2 byte value 32768...32767 (DPT 8.001)".</p> | |
| Reference value (V) (-671088...670760) | -671088...0...670760 |
| <p>This parameter specifies the internal reference value (R) for the reference function. This parameter is only available if the "data format" is set to "2 byte floating point value (DPT 9.0xx)".</p> | |
| Reference value (V) (-2147483648...2147483647) | -2147483648...0...2147483647 |
| <p>This parameter specifies the internal reference value (R) for the reference function. This parameter is only available if the "data format" is set to "4 byte value -2147483648...2147483647 (DPT 13.001)".</p> | |

- i** Two reference values (R1 & R2) can be configured if the range testing is configured as "reference function". In this case, the setting options are identical.

| | |
|---|---|
| Transmission criteria | <p>always transmit when the input is updated send only if the output changes transmit cyclically</p> |
| <p>The transmission behaviour of the output can be configured here.</p> <p>Always transmit when the input is updated: The output transmits the current object value to the KNX with every telegram that is received at the input.</p> <p>Transmit only if the output changes: The output only transmits the current object value if the object value has changed compared to the last transmission process. During the first telegram to an input after bus voltage return or after an ETS programming operation, the output always transmits to an input.</p> <p>transmit cyclically: With this setting, the output transmits the current object value to the KNX cyclically. The cyclical transmission is only started by the first valid trigger after the first telegram has been received at the input. The output also transmits as soon as a new telegram is received at the input. At the same time, the cycle time for cyclical sending is restarted!</p> | |
| Transmission delay for sending the result hours (0...99) | 0...99 |
| <p>An optional delay before result transmission (telegram at output) can be configured.</p> <p>With the setting "always transmit when the input is updated": Telegrams at the output are only transmitted after the trigger when the delay has elapsed. The delay time is restarted by each telegram at the input.</p> <p>With the setting "only transmit if the output changes": Telegrams are only sent when the object value changes at the output if the delay has expired. If the logic function is reprocessed by a new telegram at the input within the delay time and the object value changes again, then the delay restarts. If the object value of the output does not change due to new input telegrams, the delay does not restart.</p> <p>This parameter defines the hours of the delay time.</p> | |
| Minutes (0...59) | 0...59 |
| <p>This parameter defines the minutes of the delay time.</p> | |
| Seconds (0...59) | 0...59 |
| <p>This parameter defines the seconds of the delay time.</p> <p>The parameters for the transmission delay are only visible for "Transmission criteria" = "Always transmit when the input is updated" and "Only transmit when the output changes".</p> | |
| Cycle time hours (0...99) | 0...99 |
| <p>During cyclical transmission of the output, this parameter defines the cycle time.</p> <p>Setting the cycle time hours.</p> | |
| Minutes (0...59) | 0... 5 ...59 |
| <p>This parameter defines the minutes of the cycle time.</p> | |

| | |
|--|--------|
| Seconds (0...59) | 0...59 |
| <p>This parameter defines the seconds of the cycle time.</p> <p>The parameters for the cycle time are only visible if "transmission criteria" = "transmit cyclically".</p> | |

10.5.2 Comparator objects

| Object no. | Function | Name | Type | DPT | Flag |
|---|------------------|------------------|-------|-------|--------------------|
| 327, 328, 329, 330, 331, 332, 333, 334 | Comparator Input | Logic... - Input | 4-bit | 3,007 | C, (R), W, -, A |

4-bit object as input of a comparator.

This object is only available if the type of logic function is configured to "comparator" and the data format is configured to "4-bit dimming (DPT 3.007)".

| Object no. | Function | Name | Type | DPT | Flag |
|---|------------------|------------------|---------|--------|--------------------|
| 343, 344, 345, 346, 347, 348, 349, 350 | Comparator Input | Logic... - Input | 1 bytes | 20,102 | C, (R), W, -, A |

1-byte object as input of a comparator.

This object is only available if the type of logic function is configured to "comparator" and the data format is configured to "1 byte operating mode switchover (DPT 20.102)".

| Object no. | Function | Name | Type | DPT | Flag |
|---|------------------|------------------|---------|--------|--------------------|
| 343, 344, 345, 346, 347, 348, 349, 350 | Comparator Input | Logic... - Input | 1 bytes | 18,001 | C, (R), W, -, A |

1-byte object as input of a comparator.

This object is only available if the type of logic function is configured to "comparator" and the data format is configured to "1 byte scene extension (DPT 18.001)".

| Object no. | Function | Name | Type | DPT | Flag |
|---|------------------|------------------|---------|-------|--------------------|
| 343, 344, 345, 346, 347, 348, 349, 350 | Comparator Input | Logic... - Input | 1 bytes | 5,010 | C, (R), W, -, A |

1-byte object as input of a comparator.

This object is only available if the type of logic function is configured to "comparator" and the data format is configured to "1-byte value 0...255 (DPT 5.010)".

| Object no. | Function | Name | Type | DPT | Flag |
|---|------------------|------------------|---------|-------|--------------------|
| 343, 344, 345, 346, 347, 348, 349, 350 | Comparator Input | Logic... - Input | 1 bytes | 5,001 | C, (R), W, -, A |

1-byte object as input of a comparator.

This object is only available if the type of logic function is configured to "comparator" and the data format is configured to "1-byte brightness value 0...100 % (DPT 5.001)".

| Object no. | Function | Name | Type | DPT | Flag |
|---|------------------|------------------|---------|-------|--------------------|
| 359, 360, 361, 362, 363, 364, 365, 366 | Comparator Input | Logic... - Input | 2 bytes | 7,001 | C, (R), W, -, A |

2-byte object as input of a comparator.

This object is only available if the type of logic function is configured to "comparator" and the data format is configured to "2-byte value 0...65535 (DPT 7.001)".

| Object no. | Function | Name | Type | DPT | Flag |
|---|------------------|------------------|---------|-------|--------------------|
| 359, 360, 361, 362, 363, 364, 365, 366 | Comparator Input | Logic... - Input | 2 bytes | 8,001 | C, (R), W, -, A |

2-byte object as input of a comparator.

This object is only available if the type of logic function is configured to "comparator" and the data format is configured to "2-byte value -32768...32767 (DPT 8.001)".

| Object no. | Function | Name | Type | DPT | Flag |
|---|------------------|------------------|---------|-------|--------------------|
| 359, 360, 361, 362, 363, 364, 365, 366 | Comparator Input | Logic... - Input | 2 bytes | 9,xxx | C, (R), W, -, A |

2-byte object as input of a comparator.

This object is only available if the type of logic function is configured to "comparator" and the data format is configured to "2-byte floating point value (DPT 9.0xx)".

| Object no. | Function | Name | Type | DPT | Flag |
|---|------------------|------------------|---------|--------|--------------------|
| 375, 376, 377, 378, 379, 380, 381, 382 | Comparator Input | Logic... - Input | 4 bytes | 13,001 | C, (R), W, -, A |

4-byte object as input of a comparator.

This object is only available if the type of logic function is configured to "comparator" and the data format is configured to "4-byte value -2147483648...2147483647 (DPT 13.001)".

| Object no. | Function | Name | Type | DPT | Flag |
|--|-------------------|-------------------|-------|-------|---------------|
| 383, 385, 387, 389, 391, 393, 395, 397 | Comparator Output | Logic... - Output | 1-bit | 1,002 | C, R, -, T, A |
| <p>1-bit object as output of a comparator. The output object is preset to 1-bit (DPT 1.002) and outputs the result of the comparison operation (ON = true / OFF = false). This object is only available if the type of logic function is configured to "comparator".</p> | | | | | |

10.6 Limit value switch

The limit value switch works with an input whose data format can be configured, and with a 1-bit output to output the result of the threshold evaluation. The limit value switch compares the value received at the input with two configurable hysteresis threshold values. Once the upper threshold value (H2) is reached or exceeded, the output can transmit a switching telegram (e.g. ON = true). If the value falls below the lower threshold value (H1), the output can transmit another switching telegram (e.g. OFF = false).

The switching telegrams can always be configured in the ETS when the threshold values are exceeded and undershot.

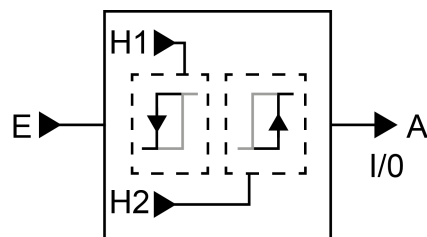

Image 29: Limit value switch

The two threshold values define a hysteresis. The hysteresis prevents frequent switching back and forth of the output, provided that the input value changes continuously in small intervals. Only when the change in value at the input exceeds the hysteresis as a whole, does the output switch the status.

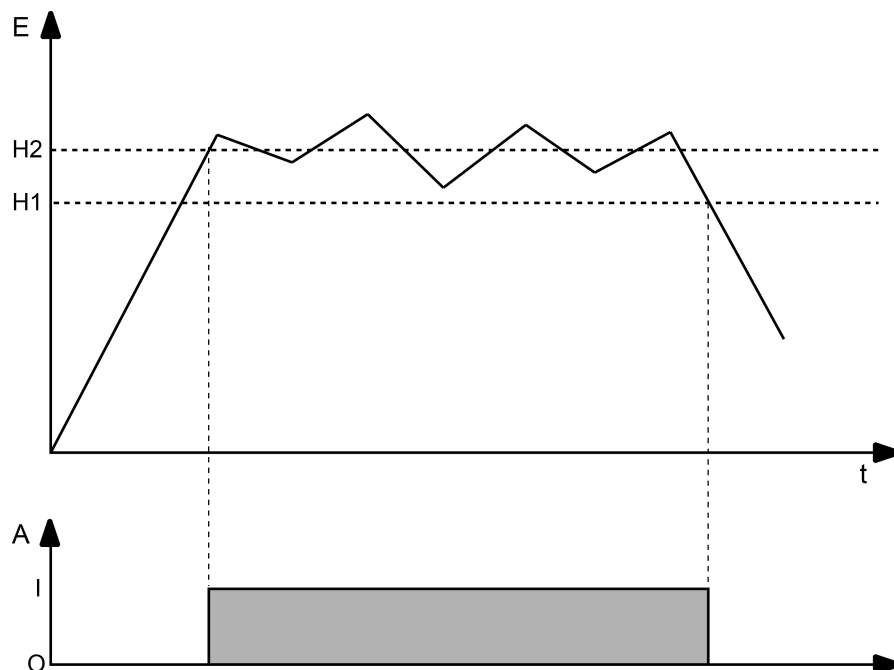

Image 30: Example of a hysteresis evaluation by upper and lower threshold value.

- i** The two threshold values can be freely configured in the ETS. Make sure that the upper threshold value is greater than the lower one!

- i** After bus voltage return or after an ETS programming operation, the output always transmits a telegram when the first value has been received at the input. The telegram depends on whether the value reaches or exceeds the upper threshold (H2) or not. If the value is less than the upper threshold, a telegram is transmitted in accordance with "Telegram upon not reaching the lower threshold". Otherwise the output transmits the "telegram on exceeding the upper threshold value".

The parameter "data format" defines the size and format of input object according to the following table. The output object is preset to 1-bit (DPT 1.002) and outputs the result of the threshold evaluation (ON = true / OFF = false). The threshold values that can be set in the ETS adapt to the input data format.

| Data format | KNX DPT |
|---------------------------------------|---------|
| 4-bit dimming | 3,007 |
| 1-byte operating mode switchover | 20,102 |
| 1- byte scene extension | 18,001 |
| 1-byte value 0...255 | 5,010 |
| 1-byte brightness value 0...100% | 5,001 |
| 2-byte value 0...65535 | 7,001 |
| 2-byte value -32768...32767 | 8,001 |
| 2-byte floating-point number | 9.0xx |
| 4-byte value -2147483648...2147483647 | 13,001 |

The transmission behaviour of the limit value switch can be configured.

10.6.1 Limit value switch parameters

Logic functions -> Logic function...

| | |
|---|--|
| Data format | <p>4-bit dimming (DPT 3.007)</p> <p>1-byte operating mode switchover (DPT 20.102)</p> <p>1-byte scene extension (DPT 18.001)</p> <p>1-byte value 0...255 (DPT 5.010)</p> <p>1-byte brightness value 0...100 % (DPT 5.001)</p> <p>2-byte value 0...65535 (DPT 7.001)</p> <p>2-byte value -32768...32767 (DPT 8.001)</p> <p>2-byte floating-point number (DPT 9.0xx)</p> <p>4-byte value -2147483648...2147483647 (DPT 13.001)</p> |
| <p>This parameter defines the size and format of input object. The output object is preset to 1-bit (DPT 1.002) and outputs the result of the threshold evaluation (ON = true / OFF = false).</p> | |
| Lower threshold value (H1) | <p>dimming darker, stop (0)</p> <p>dimming darker, 100 % (1)</p> <p>dimming darker, 50 % (2)</p> <p>dimming darker, 25 % (3)</p> <p>dimming darker, 12.5 % (4)</p> <p>dimming darker, 6 % (5)</p> <p>dimming darker, 3 % (6)</p> <p>dimming darker, 1.5 % (7)</p> <p>increase brightness, stop (8)</p> <p>increase brightness, 100 % (9)</p> <p>increase brightness, 50 % (10)</p> <p>increase brightness, 25 % (11)</p> <p>increase brightness, 12.5 % (12)</p> <p>increase brightness, 6 % (13)</p> <p>increase brightness, 3 % (14)</p> <p>increase brightness, 1.5 % (15)</p> |
| <p>This parameter defines the lower threshold value (H1) of the limit value switch.</p> <p>This parameter is only available if the "data format" is set to "4-bit dimming (DPT 3.007)".</p> | |

| | |
|--|--|
| Lower threshold value (H1) | automatic (0) comfort mode (1) standby mode (2) night operation (3) frost/heat protection (4) |
| This parameter defines the lower threshold value (H1) of the limit value switch. This parameter is only available if the "data format" is set to "1 byte operating mode switchover (DPT 20.102)". | |
| Lower threshold value (H1) | recall scene 1 (0) recall scene 2 (1) ... recall scene 64 (63) save scene 1 (128) save scene 2 (129) ... save scene 64 (191) |
| This parameter defines the lower threshold value (H1) of the limit value switch. This parameter is only available if the "data format" is set to "1 byte scene extension (DPT 18.001)". | |
| Lower threshold value (H1) (0...255) | 0...255 |
| This parameter defines the lower threshold value (H1) of the limit value switch. This parameter is only available if the "data format" is set to "1 byte value -0...255 (DPT 5.010)". | |
| Lower threshold value (H1) (0...100%) | 0...100 |
| This parameter defines the lower threshold value (H1) of the limit value switch. This parameter is only available if the "data format" is set to "1 byte brightness value 0...100 % (DPT 5.001)". | |
| Lower threshold value (H1) (0...65535) | 0...65535 |
| This parameter defines the lower threshold value (H1) of the limit value switch. This parameter is only available if the "data format" is set to "2 byte value 0...65535 (DPT 7.001)". | |

| | |
|---|---|
| Lower threshold value (H1) (-32768...32767) | -32768...0...32767 |
| This parameter defines the lower threshold value (H1) of the limit value switch. This parameter is only available if the "data format" is set to "2 byte value 32768...32767 (DPT 8.001)". | |
| Lower threshold value (H1) (-671088...670760) | -671088...0...670760 |
| This parameter defines the lower threshold value (H1) of the limit value switch. This parameter is only available if the "data format" is set to "2 byte floating point value (DPT 9.0xx)". | |
| Lower threshold value (H1) (-2147483648...2147483647) | -2147483648...0...2147483647 |
| This parameter defines the lower threshold value (H1) of the limit value switch. This parameter is only available if the "data format" is set to "4 byte value -2147483648...2147483647 (DPT 13.001)". | |
| Upper threshold value (H2) | <ul style="list-style-type: none"> dimming darker, stop (0) dimming darker, 100 % (1) dimming darker, 50 % (2) dimming darker, 25 % (3) dimming darker, 12.5 % (4) dimming darker, 6 % (5) dimming darker, 3 % (6) dimming darker, 1.5 % (7) increase brightness, stop (8) increase brightness, 100 % (9) increase brightness, 50 % (10) increase brightness, 25 % (11) increase brightness, 12.5 % (12) increase brightness, 6 % (13) increase brightness, 3 % (14) increase brightness, 1.5 % (15) |
| This parameter defines the upper threshold value (H2) of the limit value switch. This parameter is only available if the "data format" is set to "4-bit dimming (DPT 3.007)". | |

| | |
|--|--|
| Upper threshold value (H2) | automatic (0) comfort mode (1) standby mode (2) night operation (3) frost/heat protection (4) |
| This parameter defines the upper threshold value (H2) of the limit value switch. This parameter is only available if the "data format" is set to "1 byte operating mode switchover (DPT 20.102)". | |
| Upper threshold value (H2) | recall scene 1 (0) recall scene 2 (1) ... recall scene 64 (63) save scene 1 (128) save scene 2 (129) ... save scene 64 (191) |
| This parameter defines the upper threshold value (H2) of the limit value switch. This parameter is only available if the "data format" is set to "1 byte scene extension (DPT 18.001)". | |
| Upper threshold value (H2) (0...255) | 0...255 |
| This parameter defines the upper threshold value (H2) of the limit value switch. This parameter is only available if the "data format" is set to "1 byte value -0...255 (DPT 5.010)". | |
| Upper threshold value (H2) (0...100%) | 0...100 |
| This parameter defines the upper threshold value (H2) of the limit value switch. This parameter is only available if the "data format" is set to "1 byte brightness value 0...100 % (DPT 5.001)". | |
| Upper threshold value (H2) (0...65535) | 0...65535 |
| This parameter defines the upper threshold value (H2) of the limit value switch. This parameter is only available if the "data format" is set to "2 byte value 0...65535 (DPT 7.001)". | |

| | |
|---|--|
| Upper threshold value (H2) (-32768...32767) | -32768...0...32767 |
| <p>This parameter defines the upper threshold value (H2) of the limit value switch.</p> <p>This parameter is only available if the "data format" is set to "2 byte value 32768...32767 (DPT 8.001)".</p> | |
| Upper threshold value (H2) (-671088...670760) | -671088...0...670760 |
| <p>This parameter defines the upper threshold value (H2) of the limit value switch.</p> <p>This parameter is only available if the "data format" is set to "2 byte floating point value (DPT 9.0xx)".</p> | |
| Upper threshold value (H2) (-2147483648...2147483647) | -2147483648...0...2147483647 |
| <p>This parameter defines the upper threshold value (H2) of the limit value switch.</p> <p>This parameter is only available if the "data format" is set to "4 byte value -2147483648...2147483647 (DPT 13.001)".</p> | |
| Telegram on reaching or exceeding the upper threshold value | ON telegram OFF telegram |
| <p>The telegram of the output upon reaching or exceeding the upper threshold can be configured here.</p> | |
| Telegram on falling below the lower threshold value | ON telegram OFF telegram |
| <p>The telegram of the output upon not reaching the lower threshold can be configured here.</p> | |
| Transmission criteria | always transmit when the input is updated send only if the output changes transmit cyclically |
| <p>The transmission behaviour of the output can be configured here.</p> <p>Always transmit when the input is updated: The output transmits the current object value to the KNX with every telegram that is received at the input.</p> <p>Transmit only if the output changes: The output only transmits the current object value if the object value has changed compared to the last transmission process. During the first telegram to an input after bus voltage return or after an ETS programming operation, the output always transmits to an input.</p> <p>transmit cyclically: With this setting, the output transmits the current object value to the KNX cyclically. The cyclical transmission is only started by the first valid trigger after the first telegram has been received at the input. The output also transmits as soon as a new telegram is received at the input. At the same time, the cycle time for cyclical sending is restarted!</p> | |

| | |
|--|------------|
| Transmission delay for sending the result hours (0...99) | 0...99 |
| <p>An optional delay before result transmission (telegram at output) can be configured. With the setting "always transmit when the input is updated": Telegrams at the output are only transmitted after the trigger when the delay has elapsed. The delay time is restarted by each telegram at the input.</p> <p>With the setting "only transmit if the output changes": Telegrams are only sent when the object value changes at the output if the delay has expired. If the logic function is reprocessed by a new telegram at the input within the delay time and the object value changes again, then the delay restarts. If the object value of the output does not change due to new input telegrams, the delay does not restart.</p> <p>This parameter defines the hours of the delay time.</p> | |
| Minutes (0...59) | 0...59 |
| <p>This parameter defines the minutes of the delay time.</p> | |
| Seconds (0...59) | 0...59 |
| <p>This parameter defines the seconds of the delay time.</p> <p>The parameters for the transmission delay are only visible for "Transmission criteria" = "Always transmit when the input is updated" and "Only transmit when the output changes".</p> | |
| Cycle time hours (0...99) | 0...99 |
| <p>During cyclical transmission of the output, this parameter defines the cycle time. Setting the cycle time hours.</p> | |
| Minutes (0...59) | 0...5...59 |
| <p>This parameter defines the minutes of the cycle time.</p> | |
| Seconds (0...59) | 0...59 |
| <p>This parameter defines the seconds of the cycle time.</p> <p>The parameters for the cycle time are only visible if "transmission criteria" = "transmit cyclically".</p> | |

10.6.2 Limit value switch objects

| Object no. | Function | Name | Type | DPT | Flag |
|--|-----------------------------|------------------|-------|-------|--------------------|
| 327, 328, 329, 330, 331, 332, 333, 334 | Limit value switch Input | Logic... - Input | 4-bit | 3,007 | C, (R), W, -, A |
| <p>4-bit object as input of a limit value switch.</p> <p>This object is only available if the type of logic function is configured to "limit value switch" and the data format is configured to "4-bit dimming (DPT 3.007)".</p> | | | | | |

| Object no. | Function | Name | Type | DPT | Flag |
|--|-----------------------------|------------------|---------|--------|--------------------|
| 343, 344, 345, 346, 347, 348, 349, 350 | Limit value switch Input | Logic... - Input | 1 bytes | 20,102 | C, (R), W, -, A |
| <p>1-bit object as input of a limit value switch.</p> <p>This object is only available if the type of logic function is configured to "limit value switch" and the data format is configured to "1 byte operating mode switchover (DPT 20.102)".</p> | | | | | |

| Object no. | Function | Name | Type | DPT | Flag |
|--|-----------------------------|------------------|---------|--------|--------------------|
| 343, 344, 345, 346, 347, 348, 349, 350 | Limit value switch Input | Logic... - Input | 1 bytes | 18,001 | C, (R), W, -, A |
| <p>1-bit object as input of a limit value switch.</p> <p>This object is only available if the type of logic function is configured to "limit value switch" and the data format is configured to "1 byte scene extension (DPT 18.001)".</p> | | | | | |

| Object no. | Function | Name | Type | DPT | Flag |
|---|-----------------------------|------------------|---------|-------|--------------------|
| 343, 344, 345, 346, 347, 348, 349, 350 | Limit value switch Input | Logic... - Input | 1 bytes | 5,010 | C, (R), W, -, A |
| <p>1-bit object as input of a limit value switch.</p> <p>This object is only available if the type of logic function is configured to "limit value switch" and the data format is configured to "1-byte value 0...255 (DPT 5.010)".</p> | | | | | |

| Object no. | Function | Name | Type | DPT | Flag |
|---|-----------------------------|------------------|---------|-------|--------------------|
| 343, 344, 345, 346, 347, 348, 349, 350 | Limit value switch Input | Logic... - Input | 1 bytes | 5,001 | C, (R), W, -, A |

1-bit object as input of a limit value switch.

This object is only available if the type of logic function is configured to "limit value switch" and the data format is configured to "1-byte brightness value 0...100 % (DPT 5.001)".

| Object no. | Function | Name | Type | DPT | Flag |
|---|-----------------------------|------------------|---------|-------|--------------------|
| 359, 360, 361, 362, 363, 364, 365, 366 | Limit value switch Input | Logic... - Input | 2 bytes | 7,001 | C, (R), W, -, A |

2-bit object as input of a limit value switch.

This object is only available if the type of logic function is configured to "limit value switch" and the data format is configured to "2-byte value 0...65535 (DPT 7.001)".

| Object no. | Function | Name | Type | DPT | Flag |
|---|-----------------------------|------------------|---------|-------|--------------------|
| 359, 360, 361, 362, 363, 364, 365, 366 | Limit value switch Input | Logic... - Input | 2 bytes | 8,001 | C, (R), W, -, A |

2-bit object as input of a limit value switch.

This object is only available if the type of logic function is configured to "limit value switch" and the data format is configured to "2-byte value 32768...32767 (DPT 8.001)".

| Object no. | Function | Name | Type | DPT | Flag |
|---|-----------------------------|------------------|---------|-------|--------------------|
| 359, 360, 361, 362, 363, 364, 365, 366 | Limit value switch Input | Logic... - Input | 2 bytes | 9,xxx | C, (R), W, -, A |

2-bit object as input of a limit value switch.

This object is only available if the type of logic function is configured to "limit value switch" and the data format is configured to "2-byte floating point value (DPT 9.0xx)".

| Object no. | Function | Name | Type | DPT | Flag |
|---|-----------------------------|------------------|---------|--------|--------------------|
| 375, 376, 377, 378, 379, 380, 381, 382 | Limit value switch Input | Logic... - Input | 4 bytes | 13,001 | C, (R), W, -, A |

4-bit object as input of a limit value switch.

This object is only available if the type of logic function is configured to "limit value switch" and the data format is configured to "4-byte value 2147483648...2147483647 (DPT 13.001)".

| Object no. | Function | Name | Type | DPT | Flag |
|---|------------------------------|-------------------|-------|-------|---------------|
| 383, 385, 387, 389, 391, 393, 395, 397 | Limit value switch Output | Logic... - Output | 1-bit | 1,002 | C, R, -, T, A |

1-bit object as output of a limit value switch. The output object is preset to 1-bit (DPT 1.002) and outputs the result of the threshold evaluation (ON = true / OFF = false).

This object is only available if the type of logic function is configured to "limit value switch".

11 Delivery state

In the as-delivered state no telegrams are transmitted to the KNX. The relay output is set to switching operation. Control of the switching output is possible in the unprogrammed state via input 1 (switch), provided the bus voltage is switched on. The inputs 2 and 3 have no function.

The device can be programmed and put into operation via the ETS. The physical address is preset to 15.15.255

The following properties are configured for the switching output in the ex-factory state...

- Operating mode: NO contact
- Behaviour in case of bus voltage failure: open contact
- Behaviour after bus voltage return: open contact

In the factory setting, the following properties are configured for input 1...

- Function: switching
- When closing the contact: ON
- When opening the contact: OFF
- Debounce time: 30 ms
- Response to bus voltage return: no reaction
- Delay after bus voltage return: 2 s

i The application program can be unloaded with the ETS. In this case, the device has no function on the part of KNX. However, internal control of the relay output via input 1 is then possible.

Gira
Giersiepen GmbH & Co. KG
Elektro-Installations-
Systeme

Industriegebiet Mermbach
Dahlienstraße
42477 Radevormwald

Postfach 12 20
42461 Radevormwald

Deutschland

Tel +49(0)21 95 - 602-0
Fax +49(0)21 95 - 602-191

www.gira.de
info@gira.de