

Electronic switching insert

Order no.: 5405 00

Operating instructions**1 Safety instructions**

Electrical devices may only be mounted and connected by electrically skilled persons.

Serious injuries, fire or property damage possible. Please read and follow manual fully.

Danger of electric shock. Always disconnect before carrying out work on the device or load.

Danger of electric shock. Device is not suitable for disconnection from supply voltage. The load is not electrically isolated from the mains even when the device is switched off.

Risk of destruction if the set operating mode and load type do not match. Set correct operating mode when connecting or exchanging the load.

Fire hazard. For operation with inductive transformers, each transformer must be fused on the primary side in accordance with the manufacturer's instructions. Only safety transformers according to EN 61558-2-6 may be used.

These instructions are an integral part of the product, and must remain with the end customer.

2 Intended use

- Operation with suitable cover
- Mounting in appliance box according to DIN 49073

Operation with neutral conductor

- Switching of incandescent lamps, HV halogen lamps, electronic or inductive transformers with halogen or LED lamps, switchable or dimmable HV-LED or compact fluorescent lamps
- Controlling of electrothermal valve drives in combination with a room temperature controller cover

Operation without neutral conductor

- Switching of incandescent lamps, HV halogen lamps, electronic or inductive transformers with halogen or LED lamps, dimmable HV-LED or compact fluorescent lamps

Product characteristics

- Switch-on via bulb-preserving soft start
- Connection of extensions possible
- Electronic short-circuit protection with permanent switch-off after 7 seconds at the latest
- Electronic over-temperature protection

i Flickering of the connected lamps through centralised pulses from the power stations. This does not represent any defect in the device.

Operation with neutral conductor

- Device is powered via phase conductor and neutral conductor, therefore there is no leading edge phase control or trailing edge phase control.
- Enables silent switching of electrothermal valve drives in combination with a room temperature controller cover

Operation without neutral conductor

- Device is powered via the phase conductor and the connected load and therefore works in the leading edge phase control or trailing edge phase control principle
- Automatic or manual setting of the suitable operating mode for the load
- Display of the set operating mode by means LED

- i** Brief flickering upon load detection possible. No operation is possible during load detection.

3 Operation

These instructions describe operation with a button cover. Operation with different covers is described in the instructions for the cover in question. Operation using 2-wire extension with button cover or push-button corresponds to operation on the main device.

Switch load

- Press the button cover: The load is switched on or off.
- i** 3-wire extension: Press top to switch on, press bottom to switch off.

4 Information for electrically skilled persons

4.1 Fitting and electrical connection



DANGER!

Mortal danger of electric shock.

Disconnect the device. Cover up live parts.

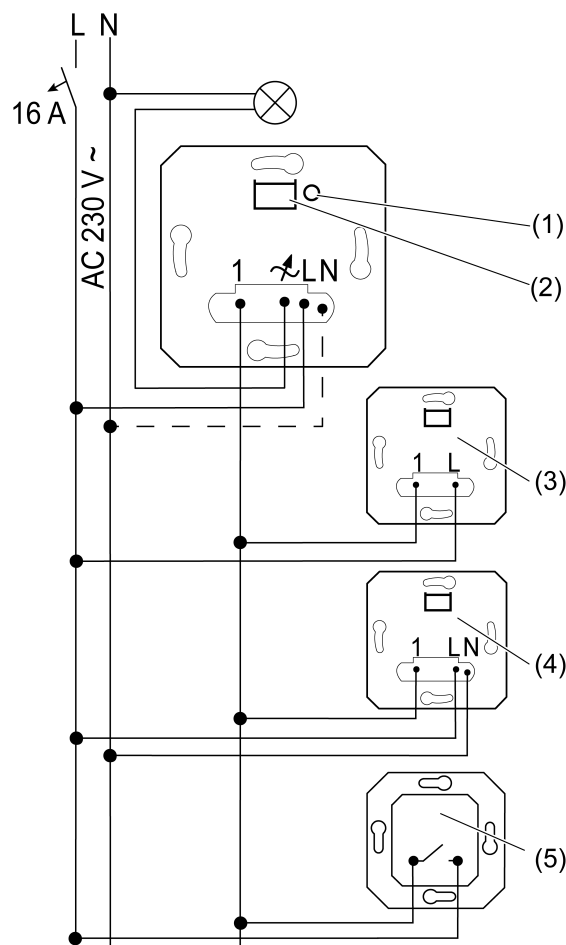

Figure 1: Connection diagram with optional extensions

- (1) Button **Test**
 (2) Display LED and connection socket for cover

Electronic switching insert

- (3) 2-wire extension
- (4) 3-wire extension
- (5) Push-button, NO contact

i Connect 600 W LED lamps or compact fluorescent lamps at most per 16 A circuit breaker. When connecting transformers, observe the data of the transformer manufacturer.

i The connected load on LED lamps is dependent on the type of lamp and installation conditions. The connected load of the specified values could vary. We cannot assume any guarantee for proper function.

Operation with neutral conductor

When switched-off, switchable LED lamps can be dimly lit or flash repeatedly. Use dimmable LED lamps.

Operation without neutral conductor

Compared with operation with neutral conductor, the maximum brightness can be reduced depending on the type of lamp.

There could be an increased likelihood of unsuitable combinations of LED lamp and switch insert.

Lit push-buttons must have a separate N terminal.

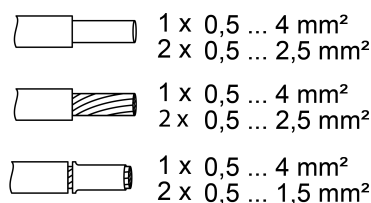

Figure 2: Clampable conductor cross-section

i The load can be switched by briefly pressing the **Test** button.

Connecting and mounting the device as a room temperature controller (Figure 3)

Recommended installation height: 1.50 m.

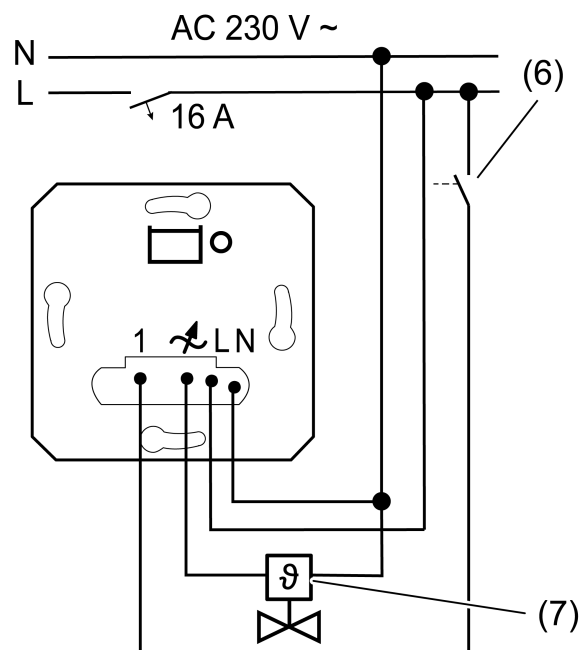

Figure 3: Connection diagram in combination with room temperature controller cover

- (6) Switching contact for switching to cooling mode
- (7) Electrothermal valve drive

i If 230 V is applied to extension input 1, cooling mode is active.

Reset the overheating protection / short-circuit protection

If the electronic overheating or short-circuit protection has been activated, separate the switch insert from the grid for a few minutes.

4.2 Commissioning

Operation with neutral conductor

The device is powered via the phase conductor and neutral conductor. There is no leading edge phase control or trailing edge phase control. Setting an operation mode is not necessary. Therefore, button **Test** (1) and LED (2) have no function for commissioning.

Operation without neutral conductor

For operation without neutral conductor, the device is powered via the phase conductor and the connected load. Therefore, the device operates in leading edge phase control or trailing edge phase control. Generally, the device automatically sets the suitable operation mode. It may, however, be necessary to set the operation mode manually.

Universal, R,L,C,LED

- Preset at the factory.
Automatic calibration to the load, dimming principle, trailing edge phase control, leading edge phase control or LED leading edge phase control.
- Incandescent lamps, HV halogen lamps, dimmable HV-LED or compact fluorescent lamps, dimmable electronic or inductive transformers for halogen or LED lamps.

LED trailing edge phase control, LED

- i** The connection of inductive transformers is not permitted.
- Incandescent lamps, HV halogen lamps, electronic transformers for halogen or LED lamps that can be dimmed according to the trailing edge phase control principle, HV-LED or compact fluorescent lamps that can be dimmed according to the trailing edge phase control principle.

LED leading edge phase control, LED

- i** The connection of inductive transformers is not permitted.
- Incandescent lamps, HV halogen lamps, electronic transformers for halogen or LED lamps that can be dimmed according to the leading edge phase control principle, HV-LED or compact fluorescent lamps that can be dimmed according to the leading edge phase control principle.

Presetting the operating mode

Precondition: Load is switched off.

- Press button **Test** (1) for longer than 4 seconds, until LED (2) lights up.



LED	Mode
GN (grün, green)	R,L,C,LED
RD (rot, red)	LED 
BU (blau, blue)	LED 

Figure 4: Assignment of LED colour for the operating mode

- Keep pressing button **Test** (1) for less than 1 second, until the necessary operating mode is selected.

The LED (2) lights up in the colour of the selected operating mode (Figure 4).

- Save the settings: Press the button **Test** (1) for more than 1 second or do not press for 30 seconds.
LED (2) goes out and the light is switched on: The operating mode is saved.

5 Technical data

Rated voltage	AC 230 V~
Mains frequency	50 / 60 Hz
Standby load depending on the cover	approx. 0.1 ... 0.5 W
Power loss	approx. 4 W
Ambient temperature	-5 ... +45 °C

Lighting loads

Connected load at 25°C (Figure 5)





			
W 20...400	W/VA 20...400	W 3...100	W/VA 20...100

Figure 5: Connected load

- i** When operating with neutral conductor or without neutral conductor in operating mode **LED** : Connected load for HV-LED lamps typ. 3...200 W, electronic transformers with NV-LED typ. 20...200 W.

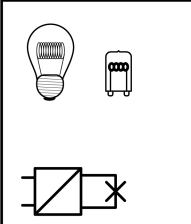
Mixed load

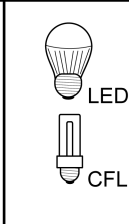
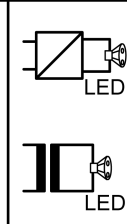
ohmic-capacitive	20 ... 400 W
capacitive-inductive	not permitted
ohmic-inductive	20 ... 400 VA
Ohmic and HV LED	typ. 3 ... 100 W
Ohmic and compact fl lamp.	typ. 3 ... 100 W

- i** Power specifications including transformer dissipation.
- i** Operate inductive transformers with at least 85% nominal load.
- i** Operation without neutral conductor in operating mode **R,L,C,LED**: Ohmic-inductive mixed load: maximum 50% proportion of ohmic load. Otherwise, an incorrect measurement is possible.
- i** Operation without neutral conductor: Minimum load 50 W. Does not apply to loads with HV-LED and compact fluorescent lamps.

Power reduction

per 5 °C in excess of 25 °C	-10%
when installed in wooden or dry construction walls	-15%
when installed in multiple combinations	-20%

Room temperature control loads

Thermal valve drive ordering no.: 2169 00

Number	1 ... 10
Number of extension units	
2-wire, push-button	unlimited
3-wire, rotary dimmer extension	10
Total line length	
Extension	max. 100 m
pwr cable	max. 100 m

6 Troubleshooting

Connected lamps flicker

Cause: the specified minimum load is below the set level.

Increase the connected load.

Connected LED lamps or compact fluorescent lamps flicker or buzz, device buzzes

Cause 1: lamps are not dimmable and device is connected without neutral conductor

Connect neutral conductor if possible, otherwise exchange lamps for dimmable lamps.

Cause 2: operating mode and lamps do not optimally match.

Check operation in another operating mode, reduce connected load as well if necessary.

Set the operating mode manually.

Exchange lamps for another type.

The device switches the load off briefly and then on again.

Cause: short-circuit protection has tripped but now there is no longer a fault.

The device has switched off and cannot be switched on again.

Cause 1: overheating protection has tripped.

Disconnect device from mains by switching off circuit breaker.

LED trailing edge phase control: Reduce the connected load. Exchange lamps for another type.

LED leading edge phase control: Reduce the connected load. Check operation in the LED trailing edge phase control setting. Exchange lamps for another type.

Let device cool down for at least 15 minutes.

Switch circuit breakers and device on again.

Cause 2: Surge protection has triggered.

LED trailing edge phase control: Check operation in the LED leading edge phase control setting, reduce connected load as well if necessary.

Exchange lamps for another type.

Cause 3: short-circuit protection has tripped.

Disconnect device from mains by switching off circuit breaker.

Eliminate short-circuit.

Switch circuit breakers and device on again.

i Short-circuit protection is not based on a conventional fuse, no metallic separation of the operational current.

Cause 4: load failure.

Check load, replace light bulb. For inductive transformers, check primary fuse.

LED lamp is dimly lit when device is switched off

Cause: LED lamp is not suitable for this device.

Use a compensation module, see accessories.

Use another type of LED lamp or an LED lamp of another manufacturer.

Device has no function

Device is operated with a room temperature controller cover and electrothermal actuator and the neutral conductor is not connected.

Connect a neutral conductor.

7 Accessories

Compensation module LED

Order no. 2375 00

8 Warranty

The warranty is provided in accordance with statutory requirements via the specialist trade. Please submit or send faulty devices postage paid together with an error description to your responsible salesperson (specialist trade/installation company/electrical specialist trade). They will forward the devices to the Gira Service Center.

Gira
Giersiepen GmbH & Co. KG
Elektro-Installations-
Systeme

Industriegebiet Mermbach
Dahlienstraße
42477 Radevormwald

Postfach 12 20
42461 Radevormwald

Deutschland

Tel +49(0)21 95 - 602-0
Fax +49(0)21 95 - 602-191

www.gira.de
info@gira.de